

Nikon

NIKONOS Speedlight

SB-102



INSTRUCTION MANUAL

NOMENCLATURE

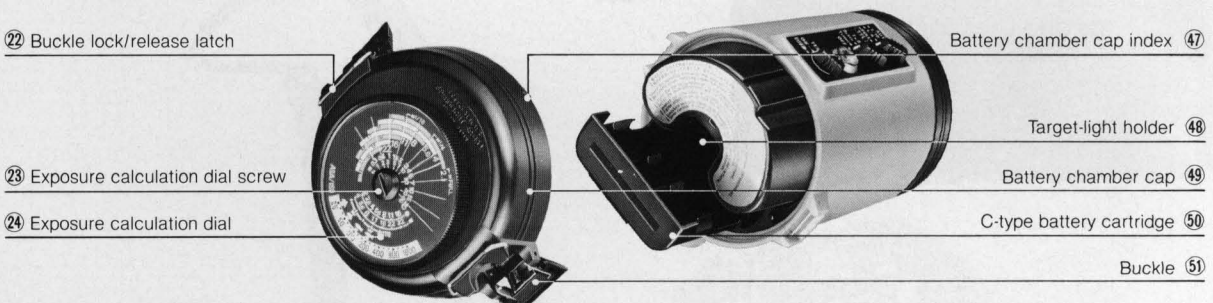
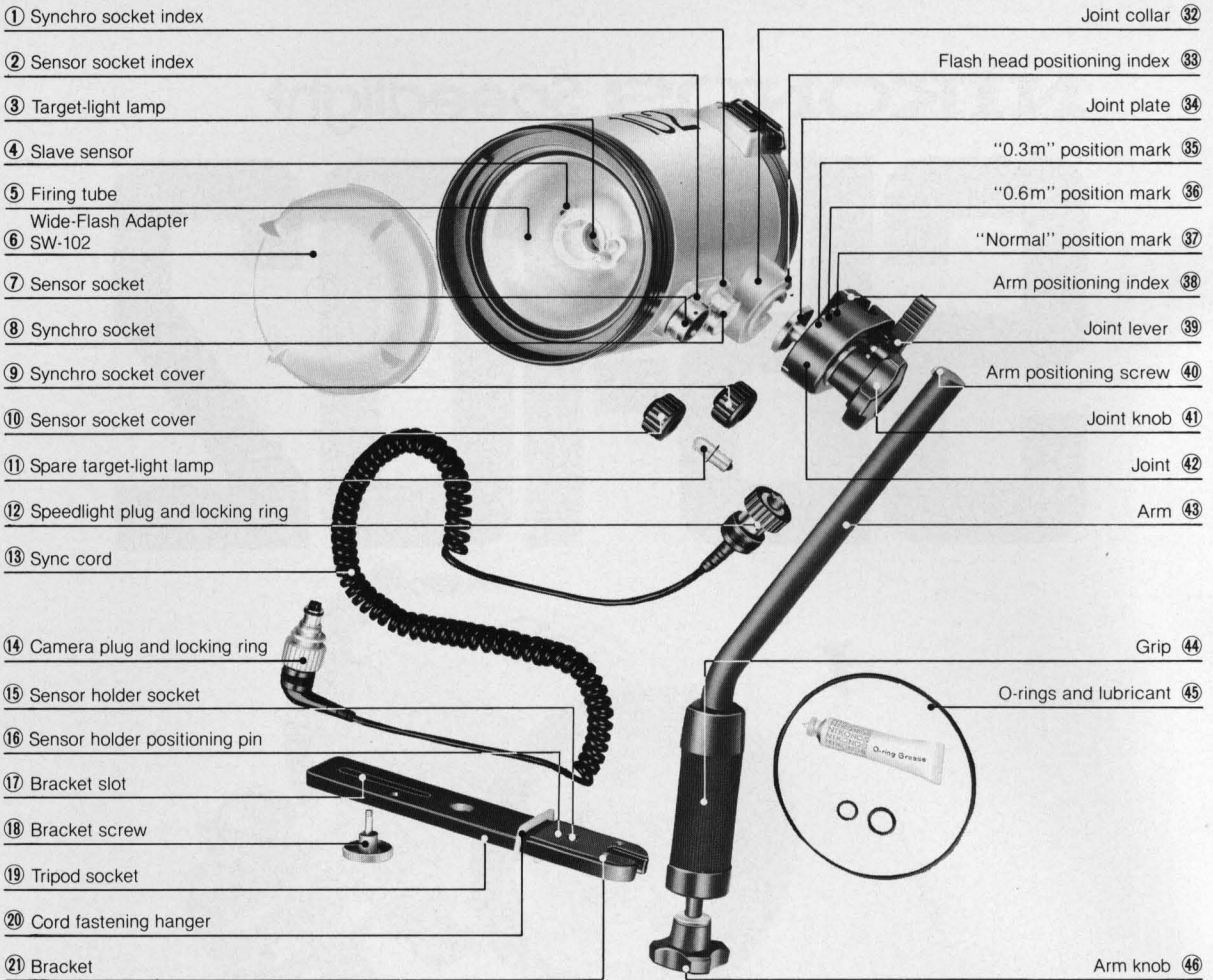

Exposure calculation dial

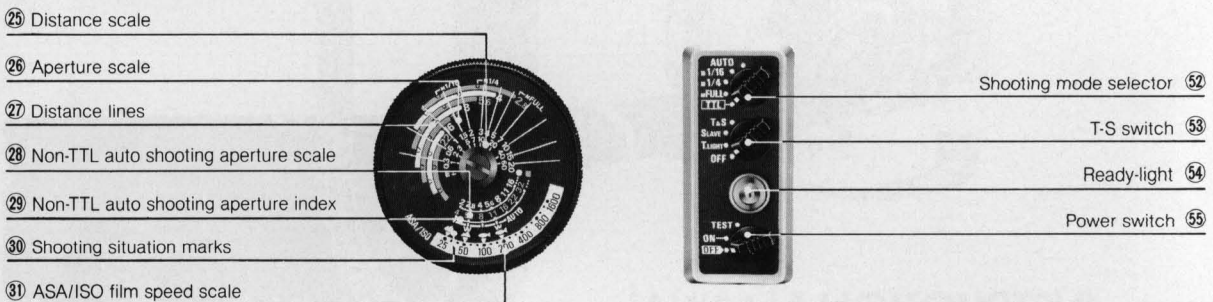

CONTENTS

NOMENCLATURE	2
FOREWORD	4
PREPARATION	4—6
Examining and lubricating the O-rings	5
The O-rings and their sealing method	6
TIPS ON SPEEDLIGHT CARE	7
BASIC OPERATIONS	8—16
CONTROLS IN DETAIL	17—30
Bracket	17
Arm	17
Joint	18
Close-Up Shooting in the Non-TTL	
Automatic Mode	18
Synchro Socket	19
Sensor Socket	19
Sensor Unit SU-101 (Optional)	20
Synchronization Speed	20
Shooting Mode Selector	21
Exposure Calculation Dial	22
TTL Automatic Flash Control	22—23
Non-TTL Automatic Flash Control	24
Manual Flash Control	25—26
Exposure Compensation	26—27
Ready-Light	27—28
Test Firing	28
Cord Fastening Hanger	29
Wide-Flash Adapter SW-102	29
Target-Light	29—30
Multiple Flash Photography	30
Daylight Fill-In Flash Photography	30
TIPS ON SPEEDLIGHT PHOTOGRAPHY	31
OPTIMUM BATTERY PERFORMANCE	32
ACCESSORIES	33—34
Sensor Unit SU-101	33
Sensor Holder (for SB-102)	33
Extension Arm	33
Double Flash Bracket	33
Double Sync Cord	34
Protectors	34
Speedlight Case SS-101 (Provided)	34
O-rings and Lubricant	34
SPECIFICATIONS	35



Speedlight Case SS-101

PREPARATION

STOP! READ THIS NOTICE BEFORE USING THE SPEEDLIGHT

The Nikon Speedlight SB-102 uses a rechargeable battery. Before using the Speedlight, read this notice carefully. It contains important information about the correct use of the Speedlight and the correct handling of the battery. Failure to follow these instructions could result in injury or property damage.

The Speedlight SB-102 is a rechargeable battery-powered camera flash. It is designed for use with Nikon SLR cameras. The Speedlight SB-102 is a compact, lightweight camera flash that provides a bright, powerful flash of light. It is easy to carry and use, and it is a great addition to any camera kit.

Before using the Speedlight, read this notice carefully. It contains important information about the correct use of the Speedlight and the correct handling of the battery. Failure to follow these instructions could result in injury or property damage.

The Speedlight SB-102 is a rechargeable battery-powered camera flash. It is designed for use with Nikon SLR cameras. The Speedlight SB-102 is a compact, lightweight camera flash that provides a bright, powerful flash of light. It is easy to carry and use, and it is a great addition to any camera kit.

FOREWORD

The Nikonos Speedlight SB-102, an amphibious high-performance electronic flash unit with a silicon-controlled rectifier and series circuitry, is designed for use with the Nikonos-V, Nikonos IV-A, and Nikonos III. The SB-102 can be submerged to a depth of 50 meters (160 feet) and withstand pressure of up to 6kg/cm² (85 lb/in²), enabling it to be used in environments where regular speedlights could not be taken.

In combination with the Nikonos-V, the SB-102 features automatic through-the-lens (TTL) flash exposure control. This means the silicon photodiode (SPD) in the Nikonos-V's shutter box reads the light passing through the lens and then automatically signals the speedlight to turn itself off when the exposure is correct. Because TTL flash offers a wide range of useable apertures and shooting distances, depth of field is easy to control and shooting as close as 0.3m (1 ft) is possible.

With the optional Sensor Unit SU-101, the SB-102 can be used for non-TTL automatic flash photography in combination with the Nikonos-V, Nikonos IV-A, and Nikonos III. In this mode, flash output is automatically controlled by the SU-101.

This speedlight has the same area of coverage as a 28mm lens. When the Wide-Flash Adapter SW-102 (provided) is used, the area of coverage increases to that of a 15mm lens.

The SB-102 also features manual control with three power settings ("FULL," "M1/4," and "M1/16"), slave

firing capability for wireless multiple flash photography, and a target-light for close-up shooting. The target-light, positioned in the center of the flash head, shoots a beam of light at the subject to help you aim the flash head at the subject. In addition to the equipment mentioned, a variety of optional accessories is available to increase the versatility of the SB-102.

Even though this speedlight is extremely easy to operate, you should still familiarize yourself with the preparatory steps and basic operations explained in the first two sections of this manual. For more detailed information, refer to "**CONTROLS IN DETAIL**" and "**TIPS ON FLASH PHOTOGRAPHY.**" A few minutes wisely invested now will pay off later in years of rewarding photographic experiences.

PREPARATION

STOP! READ THIS NOTICE BEFORE USING YOUR SB-102. THE O-RING SEALS MUST BE EXAMINED AND LUBRICATED BEFORE USE TO AVOID DAMAGING THE SPEEDLIGHT.

This Nikonos Speedlight SB-102 uses O-rings to seal and waterproof the junctions between parts. Your Nikonos Speedlight SB-102 should not be considered waterproof until you have examined the user-serviceable O-rings (one each for the battery chamber cap ④, the sync cord's ⑬ camera and speedlight plugs, and the synchro socket and sensor socket covers ⑨ ⑩). They must be in perfect, undamaged condition and properly lubricated prior to each use. Read the following instructions thoroughly to familiarize yourself with the maintenance of the O-rings.

Because the outer surface of your Nikonos Speedlight SB-102 has been specially treated to make it waterproof, it must be protected from impact. If it becomes damaged, send it to a qualified technician for service before the next use.

Your Nikonos Speedlight SB-102 is watertight only when in perfectly serviced condition, when all O-ring seals are in perfect condition, and when all components are properly assembled and closed.

Pay special attention to the instructions for installing the O-rings because they are what make the Nikonos Speedlight SB-102 watertight. For the O-rings to perform properly, they must be in perfect condition (with no cuts, tears, or other imperfections) and properly lubricated. If they are not, they will not perform properly and may allow water to enter your flash unit. To prevent

the accidental use of a defective O-ring, always discard old rings.

The channels into which the O-rings fit must be free of any foreign matter and in their original, smoothly finished condition. If they are not, the O-rings will not seat properly and may allow water to enter your flash unit. If any channel in your Nikonos Speedlight SB-102 becomes damaged, send the unit to a qualified technician for service before the next use.

Your Nikonos Speedlight SB-102 contains a series of O-rings. Some are factory-installed and cannot be serviced by you. Once each year, send your flash unit to a qualified technician so that these O-rings can be serviced. Do not attempt to disassemble the unit and service these O-rings yourself.

All of the O-rings in your Nikonos Speedlight SB-102 that can be serviced by you must be examined at the end of each dive day and, if possible, after each dive.

PREPARATION—continued

Examining and lubricating the O-rings:

1. To remove the O-rings, except those in the synchro socket and sensor socket covers, grasp the ring between your thumb and forefinger. Pinch your fingers together as you slide them in the direction of the arrow to create slack in the O-ring. Then grasp the slack portion with your other hand and pull the ring off (see Fig. 1).
To remove the O-rings in the synchro socket and sensor socket covers, use the edge of a credit card or dive card or some thin, **blunt**, instrument. **Never use a knife or other sharp-edged object.** Push up on the center of the cover with a fingertip (or pointed object), insert the card under the ring, and pull it up to lift the O-ring out (see Fig. 2). Do not scratch the O-ring in the process.
2. Visually examine each O-ring for imperfections. If any O-ring is damaged (by tears, cuts, or other imperfections), discard it immediately. If any O-ring has dirt, sand, hair, or foreign matter on it, rinse the O-ring in fresh water to remove it.
3. When lubricating the various parts of your flash unit, **use only the special non-water-soluble silicone lubricant supplied with the speedlight.** Never use other lubricants (such as Vaseline) which are water-soluble.
4. To lubricate the O-rings, smear a small amount of the special silicone lubricant on your fingertips and then gently run each O-ring between your fingertips. Never use a brush or similar object to apply the lubricant; small hairs may fall into the channel and allow water to enter the flash unit. While lubricating each O-ring, examine it with your fingertips for imperfec-

tions. If an O-ring is properly lubricated, it will glisten and will not have "gobs" of lubricant on it.

To ensure the longest possible flash unit life, apply lubricant whenever necessary. Lubrication protects the O-rings from excessive wear; it also makes it easier to attach or remove other parts.

5. Visually examine the channels into which the O-rings fit to determine that each is clean and smooth. If any channel is dirty, clean it with a non-lint-bearing material. Coat each channel with a thin film of lubricant while being careful not to apply too much.
6. Reseat all of the O-rings with your fingertips by inserting one side of the ring into the channel and holding it in position while rolling the other side of the ring into place (Fig. 3). To insert the O-rings into the channels of the synchro socket and sensor socket covers, push up on the center of the cover with a fingertip (or pointed object), place the ring over the channel, then press it down into place. Check that the O-ring is not twisted and that each of its edges is properly seated (see Fig. 4).
7. Check the surfaces which are opposite the O-rings to determine that each is clean, smooth, and free of foreign matter. Clean and lubricate the surfaces in the same manner as the channels.
8. When reattaching the parts with O-rings, be sure that each O-ring seats properly and securely. All of the O-rings must be properly aligned and not "pinched."



Fig. 1

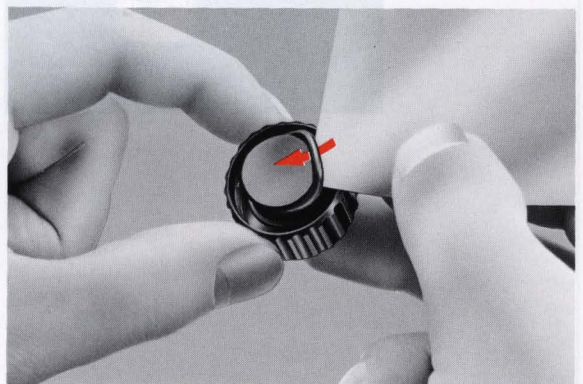

Fig. 2



Fig. 3

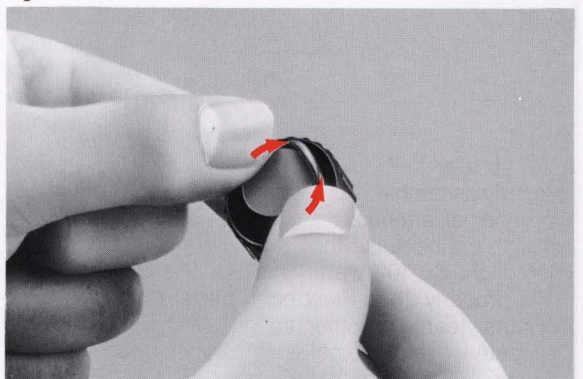

Fig. 4

PREPARATION—continued

The preceding instructions must be performed on each user-serviceable O-ring prior to each dive day and, if possible, prior to each dive. By following these procedures and all other procedures in this instruction manual, you will be able to enjoy using your Nikonos Speedlight SB-102 for many years.

Reminder: An extra set of O-rings and a tube of lubricant are supplied with the flash unit. Additional O-rings and lubricant are available from authorized Nikon dealers and service centers.

The O-rings and their sealing method

The method used by the O-rings to seal and waterproof the flash unit is shown in the following illustrations.

When a low level of pressure exists (for instance, just under the water's surface), each O-ring seals its groove by its own elastic force (see Chart A). When the pressure increases (at greater depths), the O-ring's shape is altered and its sealing ability is increased to withstand the greater pressure. The pressure changes the ring from its original "O" shape (when looking at a cross-sectional view) to a "D" shape (see Chart B).

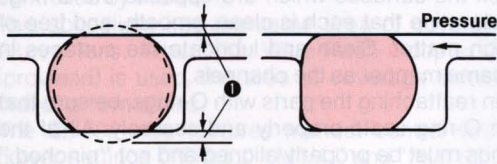
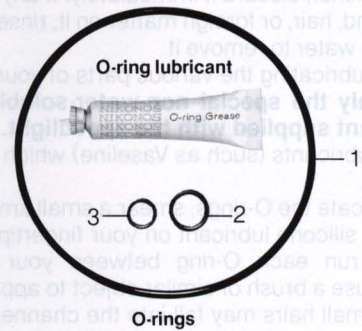

Chart A

Chart B

① Slight compression



O-rings

STOP! READ THIS NOTICE BEFORE USING YOUR SB-102. THE O-RING SEALS MUST BE EXAMINED AND LUBRICATED BEFORE USE TO AVOID DAMAGING THE SPEEDLIGHT.

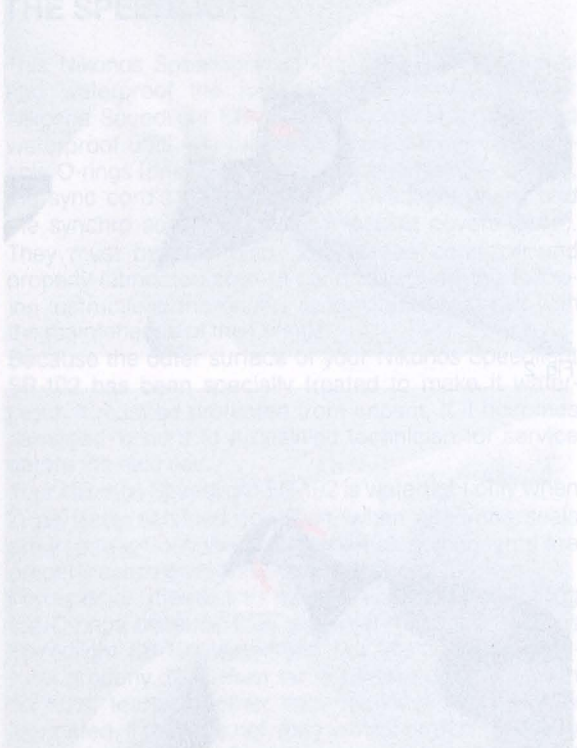

TIPS ON SPEEDLIGHT CARE

1. After using the speedlight and camera underwater, rinse them both as soon as possible in fresh running water **with the sync and sensor cords attached**. When the speedlight/camera assembly gets dirty, rinse it thoroughly in fresh water. Immediately after using it in salt water, rinse it thoroughly in fresh water to remove any residue. Otherwise, corrosion may occur in minute places like small holes or the junctions of parts. To prevent this, soak the speedlight/camera assembly overnight in a basin of fresh water, then rinse it vigorously in running water while paying special attention to the joint ②, arm ③, bracket screw ⑩, buckles ⑪, and similar parts where it is very difficult to remove mud or salt. Finally, dry the speedlight/camera assembly with a soft cloth—never by heating—**before** removing the sync and sensor cords. Be sure to wipe away any drops of water that may have seeped in past the O-ring.

When the unit is completely dry, check the O-rings. If any of them is scratched or damaged, immediately replace it with a new one by following the procedures in "**PREPARATION**."

All moving parts should be lubricated to prevent corrosion and facilitate attachment. Apply lubricant sparingly and be sure to wipe off any excess. When the speedlight will not be used for some time, store it in a cool, dry, clean place with the batteries and battery chamber cap removed.

2. **Never submerge the speedlight in water with the sync or sensor socket cover removed, or get the sync or sensor cord plugs wet.** Always make sure the sync cord and sensor cord plugs are securely attached before entering the water.
3. Never pick up or suspend the speedlight by the sync or sensor cords.
4. If an O-ring with dust, scratches, or damage is used, water may enter the flash unit and damage the electrical circuitry. Before and after diving, check the O-rings by following the procedures in "**PREPARATION**."
5. Do not allow the speedlight to be exposed to direct sunlight for long periods. And never place the speedlight in an area where the temperature is or may rise to 60°C (140°F) such as in a closed car or car trunk during warm weather.
6. High-voltage circuitry may cause electrical shock if water enters the flash unit. Should water get inside the flash unit, take it—with the batteries and battery chamber cap removed—to an authorized Nikon dealer or service center immediately.
If you experience difficulty of an electrical nature with the unit, never attempt to disassemble or service it yourself. Instead, take the unit to an authorized Nikon dealer or service center.
7. As much as possible, avoid removing the battery chamber cap near salty wind or splashing water because either may damage the unit's electrical circuitry. If the battery chamber cap must be

removed in one of these situations, for instance, to exchange batteries, use a vinyl bag to prevent water or salt from entering the unit.

8. When not using the speedlight, remove batteries to prevent damage from battery leakage. Leaking batteries may also cause dangerous combustible gases to be trapped inside the battery chamber. If the battery chamber becomes corroded by leakage, take the unit to an authorized Nikon dealer or service center.
9. To remove dirt or fingerprints, wipe with a soft, dry or silicon-treated cloth. Never use thinner, benzine, or alcohol because they may damage plastic parts. To clean the Wide-Flash Adapter SW-102, wash it with soap and water. Never use a brush.
10. If this speedlight is frequently used underwater (especially in salt water or dirty water), take it to an authorized Nikon dealer or service center for inspection on a regular basis.
11. If the speedlight is dropped or bumped against a hard surface, take it to an authorized Nikon dealer or service center for inspection even if there is no surface damage.
12. After using the speedlight, attach the dust-proof plastic caps to the sync and sensor cord plugs to protect them from damage.

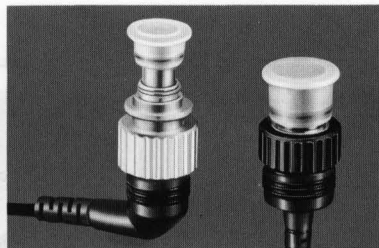

BASIC OPERATIONS



1. Unlock the buckle lock/release latches (22) and unlock the buckles (51).

Pull up the buckle lock/release latch and push the buckles outward and downward.

Note: The small numbers in circles identify parts of the speedlight as listed in the **NOMENCLATURE** section.

2. Remove the battery chamber cap (49).

Push down on the buckles until the battery chamber cap is separated from the speedlight case.

Unlock the silver buckle catches from the pins on the speedlight case and pull up on the battery chamber cap.

• After using the speedlight underwater, rinse it thoroughly in running water and wipe off any droplets with a soft cloth before removing the battery chamber cap.



3. Remove the C-type battery cartridge (50) from the battery chamber.

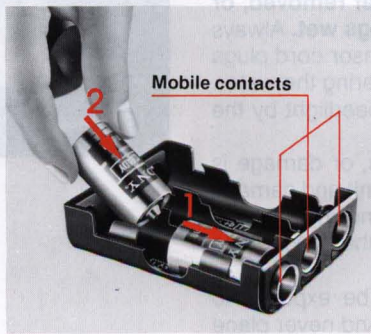

4. Install the batteries.

Install six 1.5V C-type alkaline-manganese batteries or six 1.2V NiCd batteries.

Make sure the positive and negative (+ and -) terminals are aligned as shown in the diagram on the cartridge. Make sure you always push the first battery in each slot against the mobile contact.

To remove

Remove the batteries installed in the side slots first.

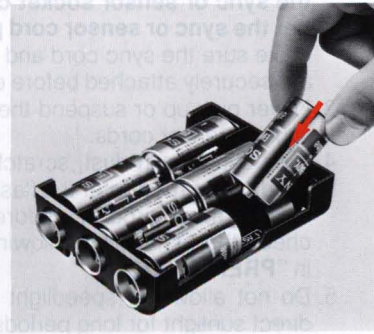

• **Do not:** Insert batteries improperly; leave flash unit turned on when not in use. Any of these may damage the flash unit. Also, **do not** leave batteries installed when the flash unit is not being used; it may cause the batteries to explode.

• Do not drop or damage the battery cartridge.

• Use only one brand or type of battery at any given time. When replacing batteries, replace all six at the same time.

• Warning: Batteries may be hot when you remove them; handle carefully.

• Use of manganese batteries is not recommended.

• Check proper battery installation before shooting. Turn flash unit on and make sure the SB-102's ready-light lights up within 30 seconds.

• Please see "OPTIMUM BATTERY PERFORMANCE," page 32.



5. Replace the C-type battery cartridge in the battery chamber.

Be sure the speedlight power switch 55 is in the "OFF" position, then align the groove on the battery cartridge with the notch on the inside of the compartment and slide the battery cartridge into the chamber.



6. Replace the battery chamber cap.

While holding the buckles away from the battery chamber cap, align the battery chamber cap index 47 with the index on the speedlight case and replace the battery chamber cap.

Check the O-ring: Before replacing the battery chamber cap, examine its O-ring for dust and scratches and be sure it is properly seated and lubricated.



7. Lock the buckles.

Push the battery chamber cap against the speedlight case so it is fully seated, hook the silver buckle catches onto the pins on the speedlight case, and pull the buckles inward and upward until they lock into position.

• When locking the buckles, be sure the silver buckle catches are hooked onto the pins on the speedlight case.



8. Lock the buckle lock/release latches.

Push the buckle lock/release latches over the edges of the buckles to lock them.



9. Loosen the joint knob 41.

To loosen the joint knob, turn it counterclockwise while holding the joint plate 34.

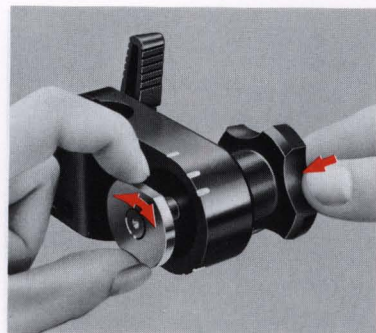

10. Properly position the joint plate.

Turn the joint knob so the flat sides of the joint plate are parallel with the flat edges of the joint.

Nikonos-V or Nikonos IV-A

Nikonos III



BASIC OPERATIONS—continued



11. Insert the joint plate into the joint collar ⑳.

While holding the base of the joint knob against the joint, slide the joint plate into the joint collar until it is fully seated.

- When inserting the joint plate into the joint collar, be sure the flat edges of the joint plate remain parallel to the flat edges of the joint.



12. Lock the joint.

Align the flash head positioning index ㉓ with the "normal" position mark on the flash head positioning scale, then turn the joint knob clockwise until the joint is locked in position.

- See page 18 for information about removing the joint.

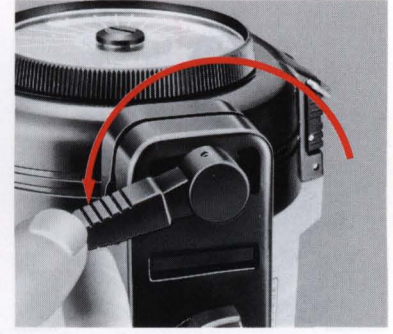

13. Loosen the joint lever ㉑.

Turn the joint lever counterclockwise as far as it will go to loosen it.



14. Insert the arm ㉔ into the joint.

Insert the arm positioning screw ㉕ into the slot in the joint. The arm can be inserted from either side of the joint. The normal position is shown in the photo.



15. Position the arm.

Align the arm positioning screw with the arm positioning index ㉓ on the joint by turning the arm 90°.



16. Lock the arm.

After aligning the arm positioning screw with the arm positioning index, turn the joint lever clockwise as far as it will go to lock the arm into position.

- Normally, the joint is locked at the top of the arm.
- Before diving, be sure the joint knob and joint lever are locked tightly.



17. Loosen the arm knob ④⑥.

Turn the arm knob counterclockwise as far as it will go to loosen it (the two bracket positioning pins on the bottom of the grip ④④ will be visible).



18. Attach the bracket ②① to the arm.

Slide the open end of the bracket between the arm knob and the grip, seat the two bracket positioning pins in the two indentations on the bracket, and turn the arm knob clockwise as far as it will go to lock the bracket into position.



• The correct arm/bracket position is with the three washers on the underside of the bracket, the rubber side of the bracket facing up, and flat side of the grip perpendicular to the bracket.

- On-land photography
- On-land photography with the wide-angle lens
- Underwater photography
- Underwater photography with the wide-angle lens

ASA/ISO film speed scale

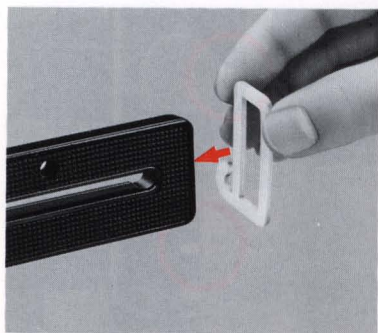
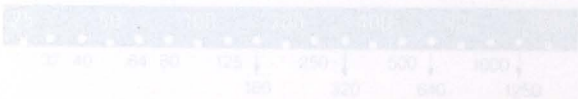

19. Attach the cord fastening hanger ②① to the bracket.

As shown in the photo, slide the cord fastening hanger onto the bracket.



20. Remove the camera's flash sync socket cover.

Turn the camera's sync socket cover counterclockwise with a coin to remove it.

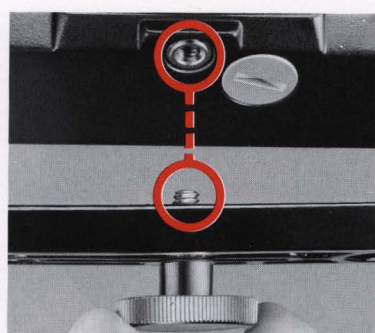

21. Attach the camera body to the bracket.

With the camera against the rubber side of the bracket and the camera's tripod socket over the bracket screw, screw the bracket screw into the camera's tripod socket until the camera and bracket are securely attached.

Nikonos-V or Nikonos IV-A

Nikonos III



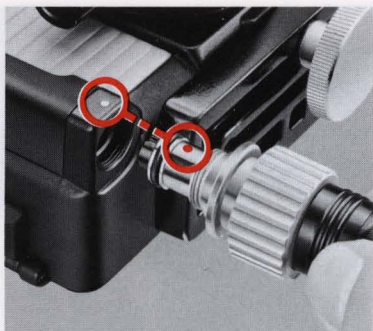

22. Connect the sync cord 13 to the camera.

Remove the dust-proof plastic cap from the sync cord's camera plug (silver). Insert the camera plug in the camera's flash socket after aligning the white index on the flash sync socket with the red index on the camera plug. When the camera plug is inserted, turn its locking ring clockwise as far as it will go to secure the plug.



Check the O-ring: Before connecting the camera plug to the camera, examine the plug's O-ring for dust and scratches and be sure it is properly seated and lubricated.

- Do not apply excessive force to the sync cord's camera plug, and avoid twisting the cord as much as possible.

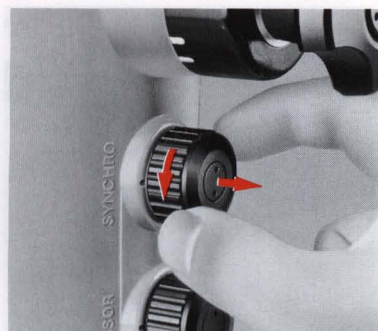

23. Remove the synchro socket cover 9.

Turn the synchro socket cover counterclockwise, then pull it up.



24. Connect the sync cord to the SB-102.

Remove the dust-proof plastic cap from the sync cord's speedlight plug (black). Insert the speedlight plug into the synchro socket after aligning the synchro socket index 1 with the red index on the speedlight plug. When the speedlight plug is inserted, turn its locking ring clockwise as far as it will go to secure the plug.



Check the O-ring: Before connecting the speedlight plug to the speedlight, examine the plug's O-ring for dust and scratches and be sure it is properly seated and lubricated.

- To keep the sync cord out of the way while shooting, attach it to the hook of the cord fastening hanger.

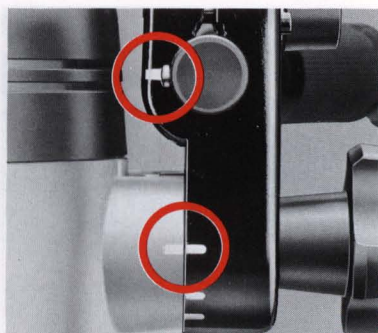

25. Confirm the position of the flash head.

Confirm that the arm positioning screw is aligned with the arm positioning index, the flash head positioning index is aligned with the "normal" position mark on the flash head positioning scale, and the flash head is facing in the same direction as the camera's lens. If the arm positioning screw is not properly aligned, loosen the joint lever to reposition it. If the flash head positioning index is not properly aligned, loosen the joint knob to reposition it.

- See page 18 for information about positioning the flash head for close-up shooting within approximately 1m (3.3ft).



26. Set the ASA/ISO film speed.

Turn the exposure calculation dial ⑳ until the correct shooting situation mark ㉑ is opposite the ASA/ISO speed of the film in the camera. Choose which mark to use according to the shooting situation:

- ▲ : On-land photography
- ⚡ : On-land photography with the wide-flash adapter
- 🐟 : Underwater photography
- ⚡🐟 : Underwater photography with the wide-flash adapter

ASA/ISO film speed scale

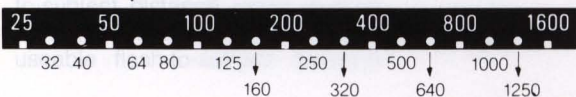

In the photograph, the shooting situation mark (🐟: underwater photography) index is aligned with ASA/ISO 100.

- For TTL operation with the Nikonos-V camera, the useable film speed range is from ASA/ISO 25 to 400.
- The ASA/ISO film speed settings are only for determining shooting distances and useable apertures; the exposure calculation dial is not electrically connected to the flash unit.
- Intermediate ASA/ISO film speed settings are indicated with dots:



27. Set the shutter speed on the camera.

When using the Nikonos-V, set the shutter speed/mode selector dial to "A" or any shutter speed setting from 1/1000 to 1/30sec.; when using the Nikonos IV-A, set the shutter speed dial to "A"; in the case of the Nikonos III, set the shutter speed dial to 1/60sec.

When using either the Nikonos-V or Nikonos IV-A, the proper synchronization speed (1/90sec.) will be automatically set when the SB-102's power switch is turned on.

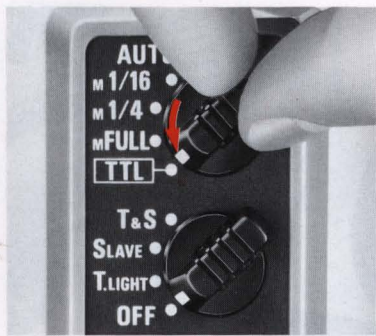
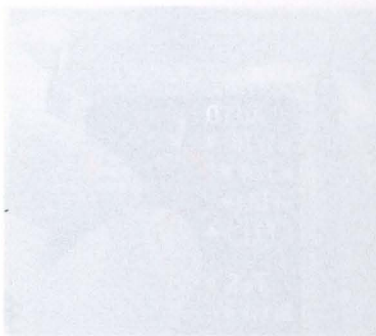

28A. TTL Automatic Operation.

A-1. Set the shooting mode selector switch ㉒ to "TTL."

• Step 28 is divided into two sections according to the camera and the shooting mode in use. The "A" steps are for TTL automatic operation with the Nikonos-V camera; the "B" steps are for non-TTL automatic operation with the Nikonos-V, Nikonos IV-A, or III (the optional Sensor Unit SU-101 is required for non-TTL automatic operation). For information about manual flash operation, see pages 25 to 26.

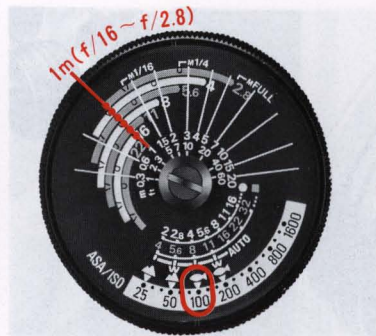

A-2. Select an f/stop with the exposure calculation dial.

Select an aperture from the range of apertures that can be used at the existing flash-to-subject distance.

For example, when the shooting situation mark (🐟: underwater photography) is set at ASA/ISO 100 and the flash-to-subject distance is 1m (3.3ft), the useable aperture range is from f/2.8 to f/16.

BASIC OPERATIONS—continued

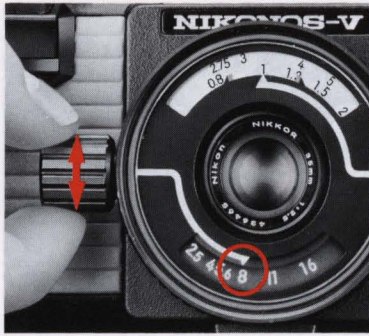

A-3. Set the f/stop on the lens.
When you have determined which f/stop to use, set this f/stop on the lens. In the photograph, f/8 is set.



28B. Non-TTL Automatic Operation.

B-1. Attach the Sensor Unit SU-101 to the camera's accessory shoe.

Turn the sensor unit's locking wheel counterclockwise as far as it will go, slip the unit's mounting foot into the camera's accessory shoe, and turn the locking wheel clockwise to tighten it.

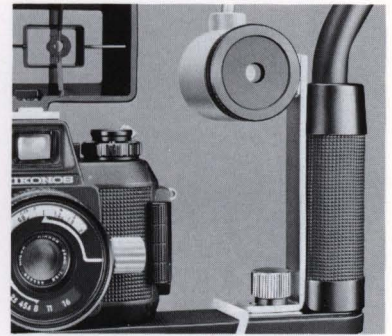

• When a plastic frame finder or optical viewfinder is mounted on the camera's accessory shoe, use the optional sensor holder to attach the SU-101 to the speedlight bracket.

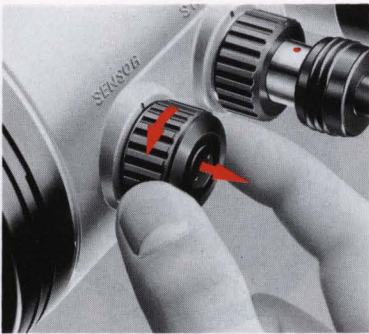

B-2. Remove the sensor socket cover ⑩.
Turn the sensor socket cover counterclockwise, then pull it up.



B-3. Connect the sensor cord to the SB-102.

Remove the dust-proof plastic cap from the sensor cord's speedlight plug (black). Insert the speedlight plug into the sensor socket after aligning the sensor socket index ② with the red index on the speedlight plug. When the speedlight plug is inserted, turn its locking ring clockwise as far as it will go to secure the plug.

Check the O-ring: Before connecting the speedlight plug to the speedlight, examine the plug's O-ring for dust and scratches and be sure it is properly seated and lubricated.

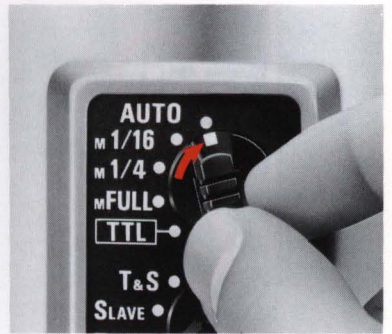

B-4. Set the shooting mode selector switch to "AUTO."

Remove the dust-proof plastic cap from the sensor cord's speedlight plug (black). Insert the speedlight plug into the sensor socket after aligning the sensor socket index ② with the red index on the speedlight plug. When the speedlight plug is inserted, turn its locking ring clockwise as far as it will go to secure the plug.

Check the O-ring: Before connecting the speedlight plug to the speedlight, examine the plug's O-ring for dust and scratches and be sure it is properly seated and lubricated.

• See page 18 for information about positioning the flash head for proper alignment.

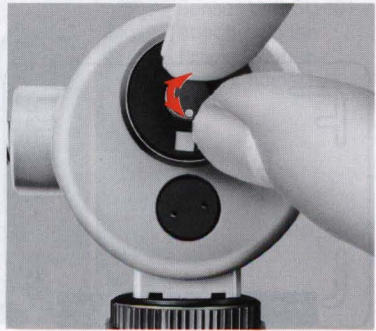
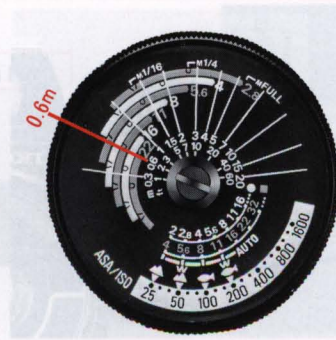
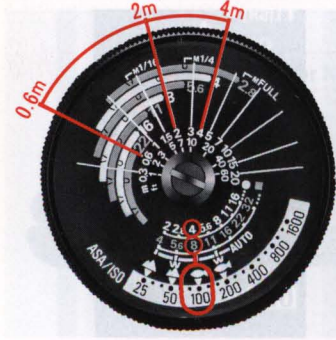

B-5. Select an f/stop with the exposure calculation dial.

Select an aperture by using the non-TTL auto shooting aperture scale 28 and non-TTL auto shooting aperture index 29.

For example, when the shooting situation mark (🐟: underwater photography) is set to ASA/ISO 100, the non-TTL auto shooting aperture index is opposite the f/8 on the green scale and the f/4 on the pink one. These then are the useable f/stops. At f/8, the useable flash-to-subject distance range is from 0.6m (2ft) to 2m (6.6ft). At f/4, the useable flash-to-subject distance

range is from 0.6m (2ft) to 4m (13ft).

- The closest shooting distance for non-TTL automatic operation is 0.6m (2ft) regardless of the film speed and whether or not the wide-flash adapter is being used.

B-6. Set the selector dial on the Sensor Unit SU-101.

Set the index on the selector dial to either the pink circle ○ or the green square □ to correspond to the color of the aperture selected in **Step B-5**. For example, if you selected f/4 in **Step B-5**, set the index to the pink circle. If you chose f/8, set the index to the green square.

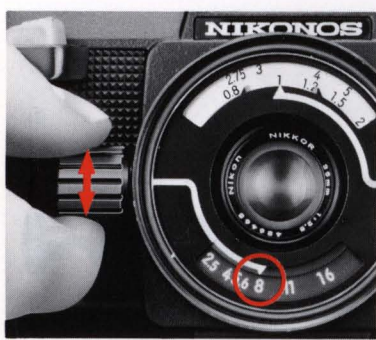

B-7. Set the f/stop on the lens.
In the photograph, f/8 is set.

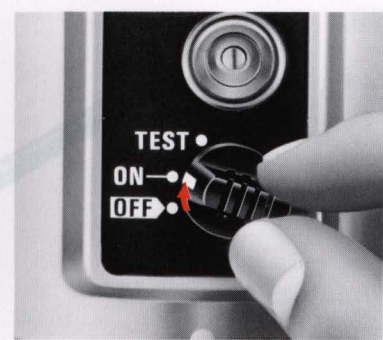

29. Turn on the flash unit.
Turn power switch to "ON."

- As soon as you turn on the SB-102 when using the Nikonos-V, the shutter speed LED indicator inside the viewfinder will blink if the shutter speed/mode selector dial is set at "A," or at any shutter speed from 1/1000 to 1/30sec. As soon as you turn on the SB-102 when using the Nikonos IV-A, the viewfinder LED turns off.
- For normal shooting, the T-S switch should be in the "OFF" position. For information about the T-S switch, see pages 29 to 30.



30. Wait for the ready-light 54 to light.

As soon as the flash ready-light lights, the SB-102 is ready to fire. Except for the Nikonos III, if the camera you are using has a viewfinder ready-light, it will light when the SB-102 is completely recycled. Note that with the Nikonos-V and Nikonos IV-A, the exposure meter must be turned on to activate the viewfinder ready-light.

Align the arm positioning screw with the index 30 on the joint by turning the arm. Then, turning the arm positioning screw with the index, turn the joint lever 31 clockwise to lock the arm into position. When it is in this manner, the speedlight's axis coincides with the lens's optical axis, even if the camera is tilted up or down on the arm. (Normally, the camera is locked at the top of the arm.) Before attaching the joint knob 32 and joint lever are locked tightly. To attach the arm to the bracket, turn the arm knob 33 counterclockwise as far as it will go to loosen it (the two bracket positioning pins on the bottom of the grip 34 will be visible). Slide the open end of the bracket between the arm knob and the grip, seat the two bracket posi-

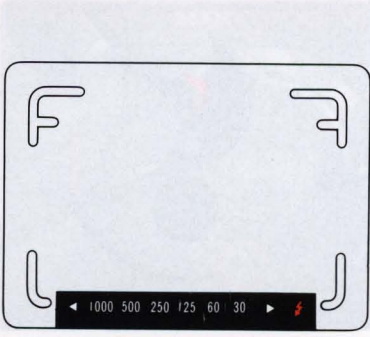

- With a set of fully recharged NiCd batteries, the ready-light will light in approximately 5 seconds; with a fresh set of alkaline-manganese batteries, it will light in approximately 14 seconds.
- If either the SB-102's or the camera's ready-light does not light, check that: the batteries are properly installed, the camera, sensor unit, and flash unit are securely connected, and the shutter speed/shooting mode and ASA/ISO film speed setting on the camera are correctly set.
- See pages 27 to 28 for information about ready-light exposure warning information.



31. Take the picture. When the shutter is released, the speedlight fires. After you take the picture, watch either the ready-light inside the camera's viewfinder or the one on the SB-102. After a few seconds, it will light again to indicate the flash unit is fully recycled and ready for the next shot.



- If the flash unit fires at its maximum output, its ready-light will blink for approximately 2 seconds after the shutter is released to warn that the shot may have been underexposed. In this case, recheck the shooting distance/aperture combination selected and use the wide-flash adapter or move closer to the subject, if necessary. This warning is also indicated by the viewfinder ready-lights of the Nikonos-V and Nikonos IV-A.

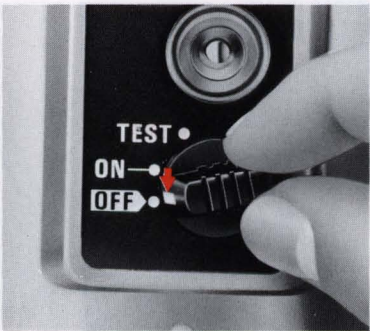

32. Turn off the flash unit. To conserve battery power between shooting sessions, turn the power switch on the speedlight to "OFF."

- Turning the power switch off between sessions will also help prevent battery leakage.

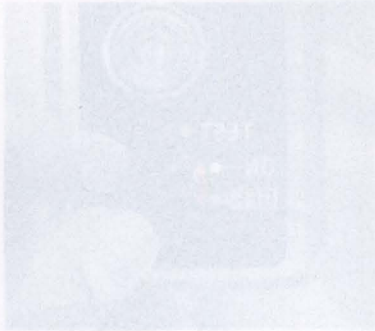

33. Check the O-ring: Before connecting the speedlight plug to the speedlight, examine the plug's O-ring for dust and scratches and be sure it is properly seated and lubricated.

34. Set the ready-light: Turn the ready-light switch on the flash unit to the 'ON' position. The ready-light will light when the camera's shutter is released. The ready-light will blink if the flash unit is firing at its maximum output. This warning is also indicated by the viewfinder ready-lights of the Nikonos-V and Nikonos IV-A.

CONTROLS IN DETAIL



Bracket 21

As indicated in the diagram there are two positions for the bracket screw 18: one for Nikonos-V and Nikonos IV-A and another for the Nikonos III. To reposition the bracket screw, unscrew it, then screw it back into the hole or the threaded end of the bracket slot 17. Once screwed into the bracket slot, the bracket screw can be moved to any position.

The larger hole in the center allows the sync cord to be connected through the bracket to the Nikonos III.

The small hole that goes completely through the bracket is the sensor holder socket 15. When a plastic frame finder or optical underwater viewfinder is mounted on the camera's accessory shoe, the optional sensor holder is used to attach the Sensor Unit SU-101 to the speedlight bracket. To attach, align the sensor holder positioning pin 16 on the top of the bracket with the hole



Sensor Unit SU-101 attached to the bracket with the sensor holder.

in the sensor holder; then screw the knob clockwise until it is tight.

The small hole on the underside of the bracket is the tripod socket 19.

- When the bracket and arm are attached to the Nikonos IV-A, certain optical finder models for older UW-Nikkor 15mm f/2.8 lenses cannot be attached. If this presents a problem for you, authorized Nikon dealers and service centers can perform the necessary modification.



Arm 43

To attach the arm to the joint 42, insert the arm positioning screw 40 into the slot in the joint from either side. Align the arm positioning screw with the arm positioning index 38 on the joint by turning the arm 90°. After aligning the arm positioning screw with the arm positioning index, turn the joint lever 39 clockwise as far as it will go to lock the arm into position. When the arm is attached in this manner, the speedlight's axis will always intersect with the lens's optical axis, even if the flash head is moved up or down on the arm. (Normally, the joint is locked at the top of the arm.) Before diving, be sure the joint knob 41 and joint lever are locked tightly.

To attach the arm to the bracket, turn the arm knob 46 counterclockwise as far as it will go to loosen it (the two bracket positioning pins on the bottom of the grip 44 will be visible). Slide the open end of the bracket between the arm knob and the grip, seat the two bracket posi-

tioning pins in the two indentations on the bracket, and turn the arm knob clockwise as far as it will go to lock the bracket into position. The correct arm/bracket position is with the two washers on the underside of the bracket, the rubber side of the bracket facing up, and the flat side of the grip perpendicular to the bracket.

CONTROLS IN DETAIL—continued



To detach

Joint 42

The joint connects the arm to the speedlight and allows the flash head to be positioned as required for various shooting situations.

The arm can be inserted from either side of the joint, the normal position is shown in the photo. When using two SB-102 Speedlights and the optional Double Flash Bracket, insert the arm that is next to the camera's film advance lever into the joint from the direction opposite that shown in the photo. (Flash head positioning scales are provided on both sides of the joint.)

The joint lever allows the flash head to be turned on the arm's axis and moved up or down the arm as required. The joint knob is used to adjust the angle of the flash head (the angle of intersection between the speedlight's axis and the lens's optical axis). The normal angle of the flash head is with the flash head positioning index 33 at the "normal" positioning mark 37 on the flash head posi-

tioning scale. The "normal" position is used for shooting between 1m (3.3ft) and infinity. For close-up shooting within approximately 1m (3.3ft), loosen the joint knob, point the flash head toward the subject, then tighten the joint knob. In addition to the "normal" position mark on the flash head positioning scale, "0.6m (2ft)" and "0.3m (1ft)" position marks 36 35 are provided for use when shooting subjects at these distances. However, when the flash head is not in the "normal" position, the joint must be attached to the top of the arm.

For information about using the target-light to position the flash head, see page 29.

To detach the joint from the speedlight, turn the joint knob counterclockwise and slide the joint plate out of the joint collar while pulling the joint knob.

Close-Up Shooting in the Non-TTL Automatic Mode

When using the SB-102 in the non-TTL automatic mode for close-up shooting within approximately 1m (3.3ft) to 0.3m (1ft), the flash head should be pointed directly at the subject. Exposure compensation will be necessary, though, to prevent the subject from being overexposed. As a rule of thumb, choose an aperture 1/2 to 1 step smaller (numerically larger f-numbers) than indicated by the exposure calculation dial. Of course, the exact amount of exposure compensation depends upon the shooting situation, so additional compensation may be required.

To determine the exact amount of exposure compensation required before going to the actual shooting location, test-shoot in a location with conditions similar to those of the actual situation (similar water quality, surroundings, subjects, and so on). If the conditions change, the amount of the exposure compensation will need to be changed correspondingly. Naturally, data calculated on land will not be applicable to underwater photography.



To attach the arm to the bracket, turn the arm knob 42 counterclockwise as far as it will go to loosen it (the two bracket positioning pins on the bottom of the grip 44 will be visible). Slide the open end of the bracket between the arm knob and the grip, seat the two bracket posi-

joint knob 42 and joint lever are locked tightly.

locked at the top of the arm.) Before diving, be sure the moved up or down on the arm. (Normally, the joint is set with the lens's optical axis, even if the flash head is in this manner, the speedlight's axis will always inter-

to lock the arm into position. When the arm is attached index, turn the joint lever 42 clockwise as far as it will go. Align the arm positioning screw with the arm positioning index 37 on the joint by turning the arm 90°. After align-

Align the arm positioning screw with the arm positioning and screw 44 into the slot in the joint from either side.

To attach the arm to the bracket, insert the arm position-

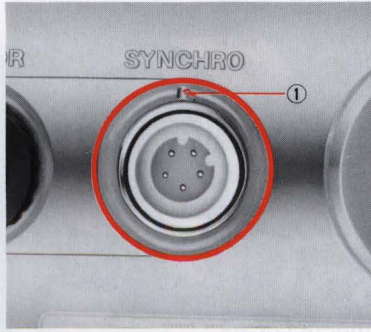
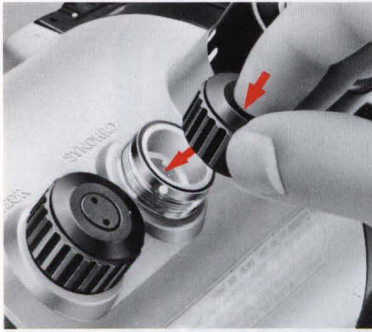

Synchro Socket ⑧

To connect the sync cord ⑬ to the speedlight, remove the synchro socket cover ⑨ by turning it counterclockwise and pulling it up. Remove the dust-proof plastic cap from the sync cord's speedlight plug ⑫ (black). Insert the speedlight plug into the synchro socket after aligning the synchro socket index ① with the red index on the speedlight plug. When the speedlight plug is inserted, turn its locking ring clockwise as far as it will go to secure the plug.

Never submerge the speedlight in water with the synchro socket cover removed or get the sync cord plugs wet. Always make sure either the synchro socket cover or the sync cord plugs are securely attached before entering the water.

After shooting underwater, wipe off any water droplets with a soft cloth **before** removing the plug to prevent water from entering the socket. Whenever the sync

cord is not being used or the speedlight is being washed with the sync cord removed from the synchro socket, attach the synchro socket cover to protect the socket. To attach the socket cover press it against the socket to seat the O-ring, then turn the locking ring clockwise as far as it will go.

- To simplify identification, both the tip of the sync cord's speedlight plug and the inside of the synchro socket are color-coded yellow.

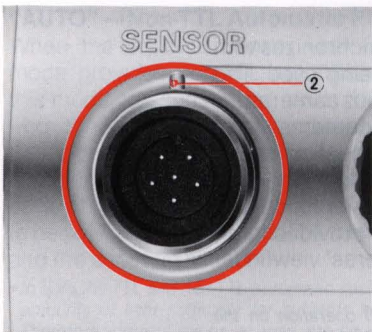

Sensor Socket ⑦

To connect the sensor cord to the speedlight for non-TTL automatic flash control, remove the sensor socket cover ⑩ by turning it counterclockwise and pulling it up. Remove the dust-proof plastic cap from the sensor cord's speedlight plug (black). Insert the speedlight plug into the sensor socket after aligning the sensor socket index ② with the red index on the speedlight plug. When the speedlight plug is inserted, turn its locking ring clockwise as far as it will go to secure the plug.

Never submerge the speedlight in water with the sensor socket cover removed or get the sensor cord plugs wet. Always make sure either the sensor socket cover or the sensor cord plugs are securely attached before entering the water.

After shooting underwater, wipe off any water droplets with a soft cloth **before** removing the plug to prevent water from entering the socket. Whenever the sensor

cord is not being used or the speedlight is being washed with the sensor cord removed from the sensor socket, attach the sensor socket cover to protect the socket. To attach the socket cover, press it against the socket to seat the O-ring, then turn the locking ring clockwise as far as it will go.

- To simplify identification, both the tip of the sensor cord's speedlight plug and the inside of the sensor socket are color-coded black.

CONTROLS IN DETAIL—continued

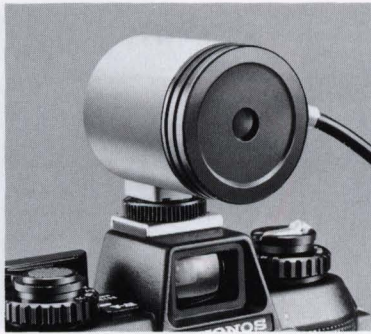

Sensor Unit SU-101 (Optional)

In combination with the optional Sensor Unit SU-101, the SB-102 provides non-TTL automatic flash exposure control. With the SB-102's shooting mode selector switch 52 at "AUTO," the Sensor Unit SU-101 reads the light reflected back from the subject while the speedlight is firing and tells the speedlight to turn itself off when the light output is sufficient for correct exposure. The selector dial on the back of the SU-101 allows one of two aperture settings to be selected.

Normally, the SU-101 is attached to the camera's accessory shoe. However, when a plastic frame finder or optical underwater viewfinder is mounted on the camera's accessory shoe, the optional sensor holder is used to attach the Sensor Unit SU-101 to the speedlight bracket.

Mounting the SU-101 on the camera: Turn the sensor unit's locking wheel counterclockwise as far as it will go, slip the unit's mounting foot into the camera's accessory shoe, and turn the locking wheel clockwise to tighten it.

Mounting the SU-101 on the bracket: Insert the sensor holder positioning pin 16 on the bracket into the sensor holder, then screw the sensor holder's screw into the sensor holder socket 15 on the bracket. To attach the SU-101 to the sensor holder, follow the same procedures as when attaching the SU-101 to the camera's accessory shoe.

Operating the SU-101: The two-position selector dial on the back of the sensor unit must be set according to the instructions in **Step B-6** (page 15). To obtain the correct exposure, position the sensor as close to the lens as possible.

• For more information about non-TTL automatic operation, see page 24.



Synchronization Speed

The shutter speed at which the SB-102 synchronizes with a camera depends upon the camera being used. The table shows the flash sync speeds of various cameras.

Both the Nikonos-V and Nikonos IV-A cameras automatically switch to the proper synchronization speed when the SB-102's power switch is turned on; when the switch is turned off, the automatic switchover function is canceled. For convenience, the SB-102 provides information and warnings through these cameras' viewfinder ready-lights.

• Aperture-priority automatic exposure mode ("A") operation on the Nikonos-V and Nikonos IV-A is canceled when the SB-102 is turned on. To determine the correct aperture, use the SB-102's exposure calculation dial (see page 22).

Camera	Sync Speed	Camera Setting	Operable Shutter Speed	Viewfinder Information	Remarks
Nikonos-V*	1/90 sec. or slower	A	1/90 sec.	Correct shutter speed blinks**	TTL operable
		1/1000 to 1/125 sec.	1/90 sec.		
		1/60 to 1/30 sec.	as set		
Nikonos IV-A*	1/90 sec. or slower	M90 or B	as set	—	TTL inoperable
		A	1/90 sec.	LED does not light	
Nikonos III	1/60 sec. or slower	M (1/90 sec.) or B	as set	—	
		—	as set	—	

* When batteries in the Nikonos-V or Nikonos IV-A are exhausted, reset the Nikonos-V's shutter speed/mode selector dial to M90 (1/90 sec.) or B (Bulb), or the Nikonos IV-A's shutter speed dial to M (1/90 sec.) or B (Bulb). TTL automatic flash control is not possible when the Nikonos-V is in the M90 or B modes.

** This indicates the correct shutter speed as determined by the subject's brightness and the aperture setting. Although this is not a speedlight function, it is helpful when using daylight fill-in flash shooting.

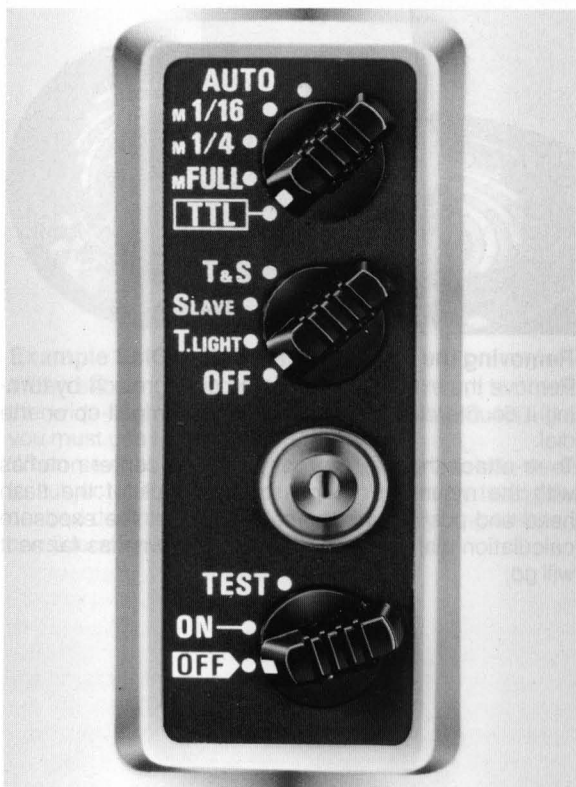

Shooting Mode Selector 52

The shooting mode selector 52 has five click-stop settings. The shooting modes that can be used with specific cameras are listed on page 28.

“TTL” position—TTL (through-the-lens) Automatic Flash Mode

This mode, which can be used only in conjunction with the Nikonos-V camera, automatically controls the flash exposure **Through-The-Lens** (TTL). In this mode, the Nikonos-V's SPD (silicon photodiode) reads the light passing through the lens and automatically signals the SB-102 to turn itself off when the exposure is correct. Because the range of useable apertures is larger (from f/2.8 to f/22 when using ASA/ISO 100 film) than with non-TTL flash, you can shoot at a variety of flash-to-subject distances. The farther the subject, the more light emitted by the flash unit; the closer the subject, the less light given off. In addition, the TTL mode makes daylight fill-in flash and close-up photography easier than ever.

- The useable film speed range for TTL operation is from ASA/ISO 25 to 400. For information about the apertures that can be used at various film speeds, see page 23.
- TTL operation is not possible with the Nikonos IV-A or III or when the Nikonos-V's shutter speed/mode selector dial is set at M90 (1/90 sec.) or B (Bulb).
- Even if the Nikonos-V's shutter speed/mode selector dial is set from 1/30 to 1/1000 sec., TTL operation is not possible when: the sync cord is not securely connected, the ASA/ISO film speed is set beyond ASA/ISO 400, or the batteries are completely exhausted.

“AUTO”—Non-TTL Automatic Flash Mode

When the optional Sensor Unit SU-101 is used, this mode provides non-TTL automatic flash operation. In this mode, the sensor unit reads the light reflected back from the subject while the speedlight is firing and tells the speedlight to turn itself off when the light output is sufficient for correct exposure. The selector dial on the back of the SU-101 allows one of two aperture settings to be selected according to the flash-to-subject distance and the shooting situation.

- In both the TTL and non-TTL automatic flash modes, the SB-102 emits amounts of light sufficient for subjects having average reflectivity. Therefore, correct exposure may not be obtainable if the subject's reflectivity is extremely low or high.

“MFULL”, “M1/4” and “M1/16”—Manual Flash Modes

Manual control is very convenient when the correct exposure cannot be obtained through non-TTL automatic operation. The SB-102 has three manual control modes for selection according to the flash-to-subject distance and the shooting situation. The guide numbers are GN 32 (16) at the “MFULL” position, GN 16 (8) at “M1/4,” and GN 8 (4) at “M1/16” (when using ASA/ISO 100 film. The guide numbers in parentheses are for underwater photography). To determine the correct aperture, use the exposure calculation dial or perform the calculations yourself (see pages 25 to 26).

CONTROLS IN DETAIL—continued



Exposure Calculation Dial 24

In flash photography, which apertures can be used is closely related to the flash-to-subject distance. To determine the useable apertures, align the shooting situation mark on the exposure calculation dial with the ASA/ISO film speed in use, find the flash-to-subject distance on the distance scale, then follow the corresponding distance line up to the aperture scale.

The dots on the ASA/ISO film speed scale indicate the following intermediate settings:

ASA/ISO film speed scale

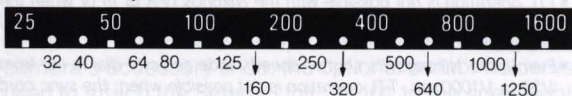

- The exposure calculation dial can be removed to clean sand or other foreign matter from behind it.



Removing the Exposure Calculation Dial:

Remove the exposure calculation dial screw 23 by turning it counterclockwise with a coin, then pull up on the dial.

To re-attach the dial, correctly align its center notches with the mounting notches on the back of the flash head and push down on the dial. Insert the exposure calculation dial screw and turn it clockwise as far as it will go.

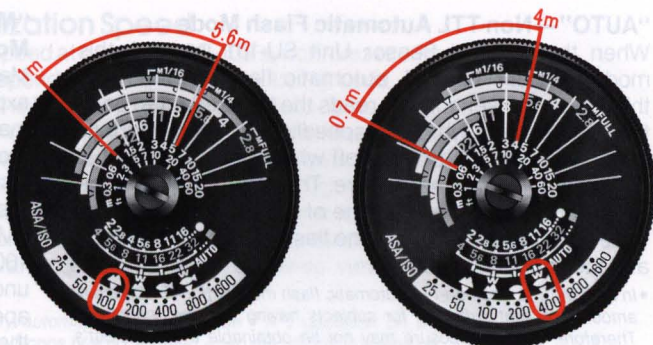

TTL Automatic Flash Control

In TTL automatic flash photography, the useable apertures are from f/2.8 to f/22 (when using ASA/ISO 100 film), although the actual range for a specific shooting situation depends upon the flash-to-subject distance. The actual ranges for specific situations can be easily determined with the exposure calculation dial.

Example 1:

When the shooting situation mark ▲ is opposite the 100 on the ASA/ISO film speed scale and you want to shoot at f/5.6, you can take pictures of subjects located between 1m (3.3ft) and 5.6m (18.4ft).

When the shooting situation mark w is opposite the 400 on the ASA/ISO film speed scale and you want to use f/5.6, you can shoot subjects located between 0.7m (2.3ft) and 4m (13.1ft).

Before you select an aperture to use, always take the flash-to-subject distance into consideration. To increase the flash-to-subject coupling distance as much as possible, select a larger f/stop (a numerically smaller f-number). In the opposite case, close-up shooting, select a smaller f/stop (a numerically larger f-number).



Example 2:

When shooting a subject underwater at 4m (13ft) with the wide-flash adapter while using ASA/ISO 100 film, you must use f/2.8.

When several f/stops are useable at a specific flash-to-subject distance, make your selection by taking the desired depth of field and speedlight recycling time into consideration.

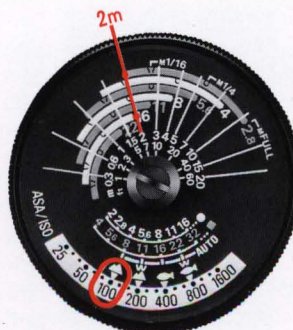

Example 3:

When shooting a subject on land at 2m (6.6ft) without the wide-flash adapter while using ASA/ISO 100 film and you want the largest depth of field possible, select f/16. If you want to minimize recycling time as much as possible, select f/2.8.

In the TTL automatic mode, the SB-102's useable ASA/ISO film speed range is from ASA/ISO 25 to 400, its useable aperture range is from f/2.8 to f/22, and its flash-to-subject coupling distance range is from 0.3m (1ft) to 22m (72.2ft). However, the relationship between the useable aperture range and the flash-to-subject coupling distance range varies according to the ASA/ISO speed of the film in use, the type of photography (on land or underwater), and whether or not the wide-flash adapter is being used.

TTL Auto Shooting Range

Unit: m (ft)

f / s t o p	ASA/ISO Film Speed					On land Without adaptor	On land With adaptor	Underwater* Without adaptor	Underwater* With adaptor
	400	200	100	50	25				
2.8	—	—	—	—	—	4 to 22 (13 to 72)	3 to 16 (9.8 to 52)	2 to 11 (6.6 to 36)	1.4 to 8 (4.6 to 26)
4	2.8	—	—	—	—	3 to 16 (9.8 to 52)	2 to 11 (6.6 to 36)	1.4 to 8 (4.6 to 26)	1 to 5.6 (3.3 to 18)
5.6	4	2.8	—	—	—	2 to 11 (6.6 to 36)	1.4 to 8 (4.6 to 26)	1 to 5.6 (3.3 to 18)	0.7 to 4 (2.3 to 13)
8	5.6	4	2.8	—	—	1.4 to 8 (4.6 to 26)	1 to 5.6 (3.3 to 18)	0.7 to 4 (2.3 to 13)	0.5 to 2.8 (1.6 to 9.2)
11	8	5.6	4	2.8	—	1 to 5.6 (3.3 to 18)	0.7 to 4 (2.3 to 13)	0.5 to 2.8 (1.6 to 9.2)	0.3 to 2 (1 to 6.6)
16	11	8	5.6	4	—	0.7 to 4 (2.3 to 13)	0.5 to 2.8 (1.6 to 9.2)	0.3 to 2 (1 to 6.6)	0.3 to 1.4 (1 to 4.6)
22	16	11	8	5.6	—	0.5 to 2.8 (1.6 to 9.2)	0.3 to 2 (1 to 6.6)	0.3 to 1.4 (1 to 4.6)	0.3 to 1 (1 to 3.3)
—	22	16	11	8	—	0.3 to 2 (1 to 6.6)	0.3 to 1.4 (1 to 4.6)	0.3 to 1 (1 to 3.3)	0.3 to 0.7 (1 to 2.3)
—	—	22	16	11	—	0.3 to 1.4 (1 to 4.6)	0.3 to 1 (1 to 3.3)	0.3 to 0.7 (1 to 2.3)	0.3 to 0.5 (1 to 1.6)

*These figures should only be used as a guide because flash-to-subject coupling distance ranges are affected by the existing conditions (water quality, surroundings, subjects, and so on). For best results, test-fire the flash before actually shooting.

... film, you can select one of three aperture/mode settings: f/16 at "M1/4," f/11 at "M1/4," or f/8 at "M1/4."

If the shooting distance changes to 5m (16.4 ft) but you still want to use "MFULL," you can select the wide-flash adapter setting between f/2.8 and f/4.

To determine the correct f/stop without using the exposure calculation (but, divide the GN (from the chart on page 26) by the flash-to-subject distance (in meters).

CONTROLS IN DETAIL—continued

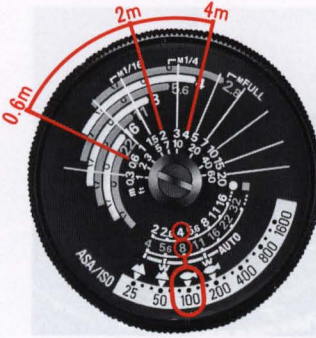
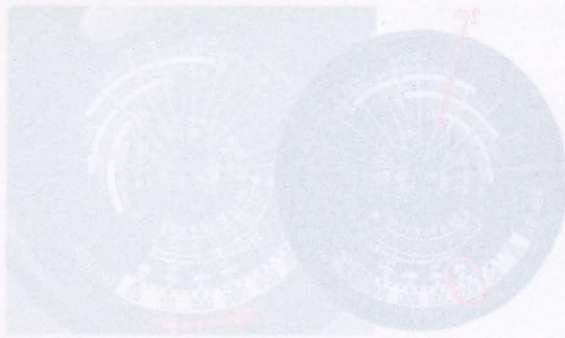

Non-TTL Automatic Flash Control

When using the optional Sensor Unit SU-101, you can select one of two useable apertures.

The useable apertures vary according to the ASA/ISO speed of the film in use, but they can be easily determined with the exposure calculation dial.

When the correct shooting situation mark is aligned with the correct speed on the ASA/ISO film speed scale, the non-TTL auto shooting aperture index Ⓢ above the shooting situation mark indicates the useable apertures (color-coded green and pink) on the non-TTL auto shooting aperture scale.

To obtain the correct exposure, choose one of the two useable f/stops and set the index on the sensor unit's selector dial to either the pink circle or the green square to correspond to the color of the aperture selected. Before doing this remember to take the flash-to-subject distance into consideration.





Example:

When shooting underwater  while using ASA/ISO 100 film, the useable f/stops indicated on the non-TTL auto shooting aperture scale are f/4 and f/8. Using the aperture scale, distance lines, and distance scale, the flash-to-subject coupling distance ranges are determined to be from 0.6m (2ft) to 4m (13.1ft) for f/4 and from 0.6m (2ft) to 2m (6.6ft) for f/8. Therefore, when the subject is beyond 2m (6.6ft), you must select f/4. When the subject is within 2m (6.6ft), you can choose either f/4 and f/8. If larger depth of field is desired, use f/8; if shorter recycling time is preferable, select f/4. Remember to set the sensor unit's selector dial to the same color-coded position as the aperture on the exposure calculation dial you have selected.



Non-TTL Auto Shooting Range

Unit: m (ft)

Shooting Situation Mark	SU-101's Selector Dial Setting	Coupling Distance
	○ (pink circle)	0.6 to 8 (2 to 26)
	□ (green square)	0.6 to 4 (2 to 13)
	○ (pink circle)	0.6 to 5.6 (2 to 18)
	□ (green square)	0.6 to 2.8 (2 to 8.9)
	○ (pink circle)	0.6 to 4 (2 to 13)
	□ (green square)	0.6 to 2 (2 to 6.6)
	○ (pink circle)	0.6 to 2.8 (2 to 8.9)
	□ (green square)	0.6 to 1.4 (2 to 4.3)

- When the shooting situation mark index is aligned with an intermediate setting on the ASA/ISO film speed scale (for example, ASA/ISO 64), the non-TTL auto shooting aperture index indicates two useable intermediate apertures on the non-TTL auto shooting aperture scale. In this situation, set one of the two intermediate apertures on the lens.
- In non-TTL automatic operation, the minimum flash-to-subject coupling distance is always 0.6m (2ft). The maximum flash-to-subject coupling distance is determined by your choice of shooting situation marks regardless of the ASA/ISO speed of the film in use. The coupling ranges that correspond to the four shooting situation marks are shown in the chart.

When the shooting situation mark index is opposite the 100 on the ASA/ISO film speed scale and you want to use f/5.6, you can select a square located between 1.7m (5.6ft) and 2m (6.6ft).

Before you select an aperture to use, always take the flash-to-subject distance into consideration. To increase the flash-to-subject coupling distance as much as possible, select a larger f/stop (a numerically smaller f-number). In the opposite case, close-up shooting, select a smaller f/stop (a numerically larger f-number).

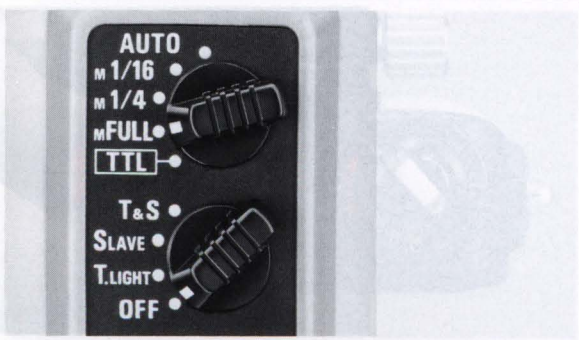

Manual Flash Control

Manual flash operation allows you to control the light output of the SB-102 by setting the shooting mode selector to one of three positions: "MFULL," "M1/4," or "M1/16."

To determine which setting to use, begin by aligning the correct shooting situation mark with the correct speed on the ASA/ISO film speed scale. Next, locate the flash-to-subject distance on the distance scale and follow the corresponding distance line up as it crosses the aperture scale. At each intersection between the distance line and an f/stop line on the aperture scale, one of four conditions will be present: 1) the distance line will intersect the extreme right-hand edge of the f/stop line (the "MFULL" mark), 2) the distance line will intersect a semicircle (the "M1/4" mark), 3) the distance line will intersect a triangle (the "M1/16" mark),

Example 3:
 Shooting a subject on land at 4m (13.1ft) using the wide-flash adapter while using ASA/ISO 100 film and "MFULL." The GN for "MFULL" is 16. Divide the GN of 16 by the flash-to-subject distance of 4m (13.1ft) to get the correct aperture, f/4. Because water decreases the GN of light, however, you must use a smaller aperture (f/5.6) as on land or you will get an overexposed underwater photograph. The underwater photograph following chart are 1/2 of the correct aperture (f/4).

or 4) the distance line will intersect an unmarked portion of the f/stop line. The first three conditions indicate the manual flash mode that can be used at those particular f/stops.

Before shooting, set the shooting mode selector to correct position and set the correct aperture on the lens.

100	1/1000	1/500	1/250	1/125	1/60	1/30	1/15	1/8	1/4	1/2	1	2	4	8	16	32	64	128	256	512	1024
200	1/1000	1/500	1/250	1/125	1/60	1/30	1/15	1/8	1/4	1/2	1	2	4	8	16	32	64	128	256	512	1024
400	1/1000	1/500	1/250	1/125	1/60	1/30	1/15	1/8	1/4	1/2	1	2	4	8	16	32	64	128	256	512	1024
800	1/1000	1/500	1/250	1/125	1/60	1/30	1/15	1/8	1/4	1/2	1	2	4	8	16	32	64	128	256	512	1024
1600	1/1000	1/500	1/250	1/125	1/60	1/30	1/15	1/8	1/4	1/2	1	2	4	8	16	32	64	128	256	512	1024

* The values in parentheses are when the Wide-Flash Adapter is being used.
 * The full amount of light is emitted when the shooting mode selector is set "MFULL" and even if not synchronized at "AUTO."

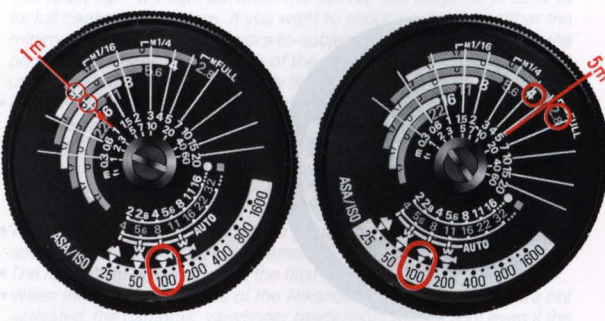

Example 1:

When shooting a subject underwater at 1m (3.3ft) without using the wide-flash adapter while using ASA/ISO 100 film, you can select one of three aperture/mode settings: f/16 at "MFULL," f/8 at "M1/4," or f/4 at "M1/16."

If the shooting distance changes to 5m (16.4ft) but you still want to use "MFULL," you should use an intermediate aperture setting between f/2.8 and f/4.

To determine the correct f/stop without using the exposure calculation dial, divide the GN (from the chart on page 26) by the flash-to-subject distance (in meters).

TTL Exposure Compensation
 When using TTL automatic, you can use the exposure compensation dial to make an exposure correction. In a situation to create intentional over- or underexposed photos, the relationship between the exposure compensation value and ASA/ISO film speed is indicated in the following chart:

100	1/1000	1/500	1/250	1/125	1/60	1/30	1/15	1/8	1/4	1/2	1	2	4	8	16	32	64	128	256	512	1024
200	1/1000	1/500	1/250	1/125	1/60	1/30	1/15	1/8	1/4	1/2	1	2	4	8	16	32	64	128	256	512	1024
400	1/1000	1/500	1/250	1/125	1/60	1/30	1/15	1/8	1/4	1/2	1	2	4	8	16	32	64	128	256	512	1024
800	1/1000	1/500	1/250	1/125	1/60	1/30	1/15	1/8	1/4	1/2	1	2	4	8	16	32	64	128	256	512	1024
1600	1/1000	1/500	1/250	1/125	1/60	1/30	1/15	1/8	1/4	1/2	1	2	4	8	16	32	64	128	256	512	1024

Example 2:

When shooting a subject underwater at 4m (13.1ft) without using the wide-flash adapter while using ASA/ISO 100 film and "MFULL," divide the GN (16) by the shooting distance [4m (13ft)] to get the correct aperture (f/4).

CONTROLS IN DETAIL—continued

Example 3:

Shooting a subject on land at 8m (26.2ft) without using the wide-flash adapter while using ASA/ISO 100 film and "MFULL": The GN for "MFULL" at ASA/ISO 100 on land is 32 (from the chart below). Divide the GN of 32 by the flash-to-subject distance of 8m to get the correct aperture, f/4. Because water absorbs a great deal of light, however, you cannot use the same GN underwater as on land or your shot will be underexposed. Instead, multiply the on-land GN by 1/2 to 1/3 for underwater photography. (The underwater GNs shown in the following chart are 1/2 of the corresponding on-land GNs.)



Exposure Compensation

When the Nikonos-V is used with the SB-102 in the TTL or non-TTL flash mode, exposure compensation is required for over- or underexposing the picture to match subject or shooting conditions. Each procedure is different, so read the following instructions carefully before shooting.

In addition, if you photograph a subject with very high reflectivity, such as a mirror or metallic surface, underexposure is almost certain to occur. To prevent this, use manual flash control.

Guide Numbers in the Manual Mode

Film speed (ASA/ISO)	On-land shooting			Underwater shooting		
	"MFULL"	"M1/4"	"M1/16"	"MFULL"	"M1/4"	"M1/16"
1600	128 (90)	64 (45)	32 (22)	64 (45)	32 (22)	16 (11)
800	90 (64)	45 (32)	22 (16)	45 (32)	22 (16)	11 (8)
400	64 (45)	32 (22)	16 (11)	32 (22)	16 (11)	8 (5.6)
200	45 (32)	22 (16)	11 (8)	22 (16)	11 (8)	5.6 (4)
100	32 (22)	16 (11)	8 (5.6)	16 (11)	8 (5.6)	4 (2.8)
50	22 (16)	11 (8)	5.6 (4)	11 (8)	5.6 (4)	2.8 (2)
25	16 (11)	8 (5.6)	4 (2.8)	8 (5.6)	4 (2.8)	2 (1.4)

- The values in parentheses are when the Wide-Flash Adaptor SW-102 is being used.
- The full amount of light is emitted when the shooting mode selector is at "MFULL" and, even if not synchronized, at "AUTO."

TTL Exposure Compensation

When using TTL automatic flash control with the Nikonos-V camera, you can use its ASA/ISO film speed dial to make an exposure compensation for the shooting situation or to create intentionally over- or underexposed photos.

The relationship between the exposure compensation value and ASA/ISO film speed dial setting is shown in the following chart:

ASA/ISO Film Speed in use	Exposure Compensation Value (New ASA/ISO Setting)				
	+2	+1	0	-1	-2
25	—	—	25	50	100
50	—	25	50	100	200
100	25	50	100	200	400
200	50	100	200	400	—
400	100	200	400	—	—

The useable aperture range for TTL automatic flash photography changes according to the exposure compensation value being used. Before using the exposure calculation dial to determine the useable aperture range, align the correct shooting situation mark with new (compensation) setting on the ASA/ISO film speed scale.



For example, to make a +2 exposure compensation when using ASA/ISO 100 film, reset the ASA/ISO film speed scale to ASA/ISO 25, then read the modified shooting distance from the dial.

- Positive (+) exposure compensation cannot be made at some film speeds, and negative (-) exposure compensation cannot be made at other film speeds. In these cases, make the necessary compensation in the non-TTL automatic mode (see page 24) or use one of the manual flash modes.
- When you finish making the exposure compensation, be sure to reset the ASA/ISO film speed dial on the Nikonos-V and the ASA/ISO film speed scale on the speedlight.

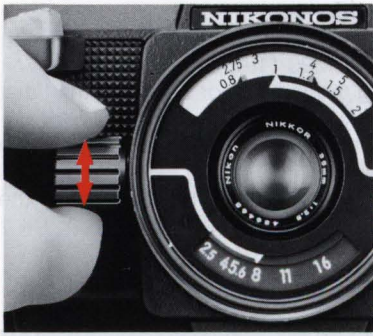

Non-TTL Automatic Flash Exposure Compensation

When shooting in the non-TTL automatic flash exposure mode, exposure compensation can be made by stopping down or opening up the lens. To compensate for a dark subject, use a 1/2- to 2-step smaller aperture (a numerically larger f-number). To compensate for a light subject, use a 1/2- to 2-step larger aperture (a numerically smaller f-number).

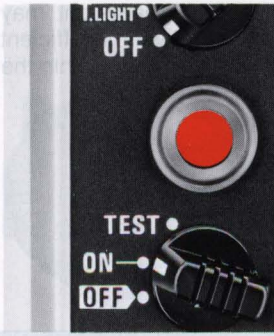

Ready-Light ⁵⁴

After its power switch is turned on, the ready-light on the SB-102 will light to indicate that the SB-102 has recycled and is ready to fire. If you are using either a Nikonos-V or Nikonos IV-A camera, its viewfinder ready-light will also light at the same time to let you know the flash unit is ready for the next shot.

In addition, the viewfinder ready-lights of the Nikonos-V and Nikonos IV-A blink to warn of improper settings. If this happens, check that the camera and flash unit are securely connected, and the shutter speed/shooting mode and ASA/ISO film speed on the camera are correctly set.

- The ready-light will light up when the SB-102 has recycled to 80% of its full capacity. Therefore, if you want to shoot a subject at either the minimum or maximum camera-to-subject coupling distance in the non-TTL automatic mode or one of the manual modes, it is best to wait until a few seconds after the ready-light has lighted.
- As the voltage of the batteries decreases with use, the GN of the flash unit decreases slightly.
- The voltage of NiCd batteries decreases rapidly when their power is almost exhausted, increasing the recycling time. When this occurs, stop using them immediately and recharge them or they may be damaged.
- When using alkaline-manganese batteries, if recycling takes 30 seconds or longer, replace the batteries with a fresh set.
- The ready-light goes out when the flash unit is turned off.
- When the exposure meters of the Nikonos-V and Nikonos IV-A are not activated, the cameras' viewfinder ready-lights will not light even if the speedlight is turned on (except when the shutter speed/mode selector dial or shutter speed dial is set at M90 or M). Always confirm that the viewfinder ready-light is lighted before shooting.
- When the shutter speed/mode selector dial or shutter speed dial of the Nikonos-V or Nikonos IV-A is set at M90 or M, the viewfinder ready-light lights when the flash unit's ready-light lights.



Warning Function: Beyond Auto Shooting Range

In the TTL and non-TTL automatic modes, the ready-lights on the flash unit and in the camera's viewfinder blink for approximately 2 seconds if the flash unit has fired at its maximum output to indicate that the light output may not have been sufficient for correct exposure. If this happens, recheck the flash-to-subject distance. If it is beyond the coupling distance range, use a larger aperture (a numerically smaller f-number), if possible, or move closer to the subject.

Because the voltage of batteries (especially alkaline-manganese batteries) decrease rapidly with use, the GN of the flash unit will decrease slightly. The flash output of the SB-102 also varies according to the amount of ambient light and the subject's reflectivity.

CONTROLS IN DETAIL—continued

Because of these three factors, the ready-light may blink to indicate that the light output was insufficient for correct exposure even if the subject was within the coupling distance range.

Other Warning Functions:

1. When the shutter speed/mode selector dial of the Nikonos-V is set to M90 (1/90sec.) or B (Bulb), or when the shooting mode selector switch of the flash unit is set to "TTL" when using the Nikonos IV-A.
2. When the sync cord is not securely connected to the Nikonos-V.
3. When the ASA/ISO film speed setting dial of the Nikonos-V is set to beyond ASA/ISO 400.

Camera and Speedlight Ready-Lights¹

Camera	Shutter-Speed Setting (sec.)	Shooting mode	SB-102 ready-light	Camera ready-light	
				Meter ON	Meter OFF
Nikonos-V	A, 1/1000 to 1/30	TTL	Lights	Lights or blinks ²	Does not light
	A, 1/1000 to 1/30	MFULL, M1/4, M1/16, AUTO ³	Lights	Lights	Does not light
	M90 (1/90), B	TTL	Lights	—	Blinks
	M90 (1/90), B	MFULL, M1/4, M1/16, AUTO ³	Lights	—	Lights
Nikonos IV-A	A	TTL	Lights	Blinks	Does not light
	A	MFULL, M1/4, M1/16, AUTO ³	Lights	Lights	Does not light
	M (1/90), B	TTL	Lights	—	Blinks
	M (1/90), B	MFULL, M1/4, M1/16, AUTO ³	Lights	—	Lights
Nikonos III	1/500 to 1/30 ⁴	TTL	Lights	—	—
	1/500 to 1/30 ⁴	MFULL, M1/4, M1/16, AUTO ³	Lights	—	—

1. When the speedlight has recycled.

2. When the ASA/ISO film speed dial is set to beyond ASA/ISO 400.

3. In the auto mode, the optional Sensor Unit SU-101 is required.

4. Speeds of 1/500 second, 1/250 second, and 1/125 second cannot be used because the sync shutter speed is 1/90 second or slower.

— = Proper flash synchronization is not possible because the shutter speed/shooting mode is improperly set.

• When the camera is set at M90 or M, the camera's exposure meter will not operate even if the shutter release button is depressed.



Test Firing

To determine whether or not the flash illumination is sufficient for a correct exposure, especially when using the non-TTL automatic mode with distant subjects or when using bounce-flash photography, test-fire the flash unit. To test-fire the SB-102, turn its power switch to "TEST" after the ready-light on the flash unit lights. If the ready-light on the flash unit begins blinking after test-firing, switch to a larger aperture (a numerically smaller f-number), if possible, or move closer to the subject before shooting.

This setting also enables you to repeatedly fire the flash manually with the camera set at B (open-flash firing) to create multiple-exposure stroboscopic effects or "paint" the scene with light. When doing this, disconnect the speedlight from the camera or the flash unit will not fire, even if its power switch is set at "TEST." (Remove the sync cord and replace the camera's flash

socket and the flash unit's sync socket cover **before entering the water.**)

• After test firing or open-flash firing, reset the speedlight's power switch to "ON" or "OFF."

In the TTL mode, the shutter must be released to test-fire the flash unit, but if there is no film in the camera, the ready-light will blink even if the light output was sufficient for correct exposure.

To avoid this, place a strip of cut film (provided it is not too old) or a piece of gray paper under the camera's film pressure plate, then release the shutter.

• Even if two speedlights are connected by the optional Double Sync Cord, only the speedlight that is being test-fired will fire.

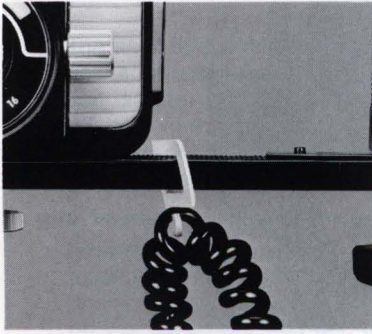

Cord Fastening Hanger ⑳

This hanger secures the sync cord to the bracket to keep it out of the way while shooting.

To use the cord fastening hanger, attach it to the speedlight bracket as shown in the photo, then attach the sync cord to the hook.



Wide-Flash Adapter SW-102 ⑥

Designed specifically for use with this flash unit, the Wide-Flash Adapter SW-102 increases the SB-102's angle of coverage from that of a 28mm lens (on land and underwater) to that of a 15mm lens (underwater). When the adapter is attached, the SB-102's GN is reduced to 22 on land and 11 underwater (when using ASA/ISO 100 film at "MFULL").

- When the SW-102 is attached, be sure to use the correct shooting situation marks (⚡ for underwater or ⚡ for on-land shooting) when setting the exposure calculation dial.
- To prevent overexposure during close-up shooting within approximately 0.6m (2ft), attach the adapter even if using a lens other than the UW-Nikkor 15mm f/2.8N.
- To prevent the loss of the SW-102 and to enable it to be attached quickly, tie one end of a piece of string to its hole and tie the other end to the speedlight.

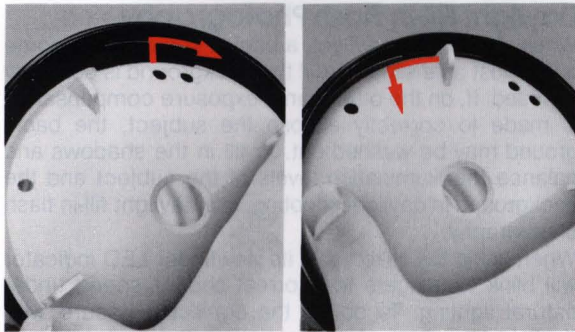

Attaching the SW-102

To attach the adapter, align the adapter's mounting notches with the adapter mounting catches on the flash head, push the adapter onto the flash head as shown in the photo, then turn the adapter clockwise as far as it will go.

To remove: Turn the adapter counterclockwise and pull it off.

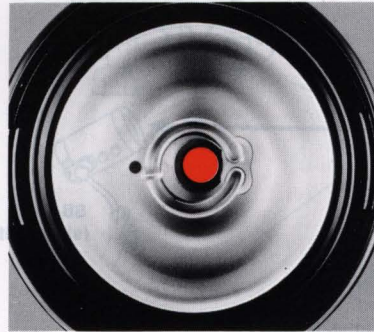

Target-Light Function

The SB-102's target-light enables the flash head to be accurately positioned for close-up shooting regardless of whether or not the speedlight is mounted on the joint/arm. When the speedlight's power switch is turned on and the T-S switch ⑤③ is turned to "T.LIGHT" or "T&S," the target-light will emit a beam of light to indicate the direction of the flash head. To accurately position the flash head, reset it by using the joint and arm until the beam of light falls on the center of the subject.

- Although you can shoot while the target-light is on, it is better to turn the T-S switch to "OFF" or "SLAVE" before shooting to conserve battery power.
- If the target-light is on when the flash is fired, the target-light will flicker for a few moments. This does not indicate a malfunction.
- Recycling takes slightly longer when the target-light is being used.

CONTROLS IN DETAIL—continued

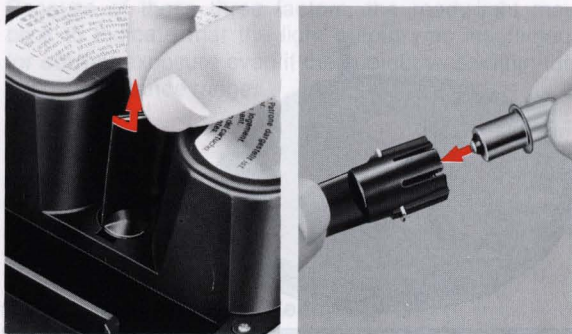

Replacing the Target-Light

If the target-light burns out, replace it with a new one (provided) by performing the following procedures:

1. Remove the battery chamber cap (see page 8).
2. Remove the C-type battery cartridge.
3. Turn the target-light holder (48) counterclockwise approximately 45°.
4. Pull up on the holder.
5. Remove the old lamp and replace it with a new one.
6. Replace the holder and turn it clockwise 45°.
7. Replace the C-type battery cartridge.
8. Replace the battery chamber cap.

• The target-light can also be replaced by an authorized Nikon dealer or service center if you desire.



Multiple Flash Photography

The SB-102 has wireless slave flash capability, enabling it to be triggered by the light fired from another flash unit.

For multiple flash operation as shown in the diagram, use either an SB-102 or SB-101 as the master flash unit (the speedlight connected to the camera). Set the T-S switch of the slave flash unit (the speedlight **not** connected to the camera) to "SLAVE" or "T & S."

After confirming that the flash units' ready-lights are lighted, release the shutter to fire the master flash unit. At the same time, the slave unit will be triggered by the light fired from the master flash unit.

- There is no limit to the number of SB-102 Speedlights that can be used as slave flash units at one time.
- For multiple flash operation, all flash units must be in the manual mode. In the TTL and non-TTL automatic shooting modes, the correct exposure cannot be obtained because the light from each speedlight alters the exposure measurement.

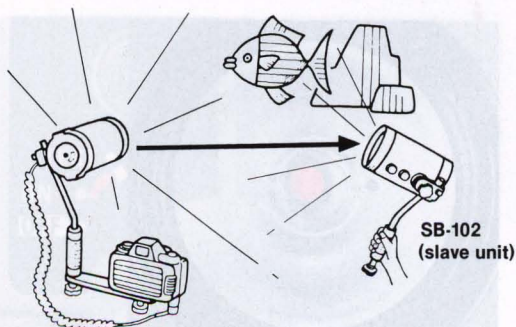

SB-102 or SB-101 (master unit)

When two or more flash units are the same distance from the subject and face approximately the same direction, the combined GN of the units can be determined with the following equation:

$$\text{Combined GN} = \sqrt{\text{GN}_1^2 + \text{GN}_2^2 + \text{GN}_3^2 + \dots}$$

Where GN 1, 2, 3... are the guide numbers of the flash units

- Because the slave flash unit is triggered when the light from the master flash unit reaches it directly or is reflected to it by the subject, if the light from the master flash unit does not reach the slave flash unit or if there are strong light sources nearby, the slave flash unit will not fire. For best results, test-fire the entire multiple flash system by test firing the master flash unit before shooting.
- During slave flash photography, avoid other persons using speedlights or the bursts from their flash units will trigger your slave unit.
- The slave flash unit may be triggered by the light from a fluorescent lamp.

Daylight Fill-In Flash Photography

When shooting in daylight, a backlit subject may come out almost as a silhouette if the background is correctly exposed. If, on the other hand, exposure compensation is made to correctly expose the subject, the background may be washed out. To fill in the shadows and balance the illumination levels of the subject and the background in daylight shooting, use daylight fill-in flash photography.

When using the Nikonos-V, its viewfinder LED indicator will blink to indicate the correct shutter speed under natural lighting. To obtain the correct exposure with daylight fill-in flash shooting, turn on the flash unit and select progressively smaller f/stops (numerically larger f-numbers) until the camera's 1/125 second and 1/60 second LEDs begin blinking or until either the 1/60 second or the 1/30 second LED indicator blinks. Make sure the subject is within the coupling distance range and, if the viewfinder ready-light is lighted, release the shutter.

Operable shutter speed (1/90 sec.)

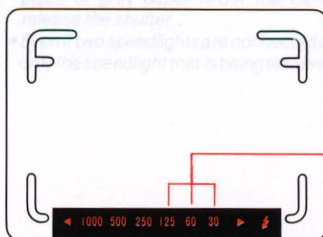

Adjust the aperture until one or two of these LED indicators begins blinking.

TIPS ON SPEEDLIGHT PHOTOGRAPHY

1. The flash-to-subject coupling distances and useable apertures indicated by the exposure calculation dial are for clear-water shooting. Therefore, the correct exposure will be different if the water is muddy or has floating particles, and some exposure compensation must be made.
2. In shallower depths with natural lighting, overexposure may occur when shooting in the automatic mode. To prevent this, use the smallest aperture (the numerically largest f-number) possible or turn off the speedlight and use only natural lighting. When shooting with the Nikonos-V, the correct shutter speed for the lighting conditions is displayed in the viewfinder. (For more information, refer to the camera's instruction manual.)
3. When the bracket and arm are attached to the Nikonos IV-A, certain optical finder models for older UW-Nikkor 15mm f/2.8 lenses cannot be attached. If this presents a problem for you, authorized Nikon dealers and service centers can perform the necessary modifications.
4. One of the benefits of using a speedlight underwater is that it restores natural colors to subjects by removing the water's bluish cast. Occasionally, though, you may want to include that bluishness in your photos. Normally, this is rather difficult to do because the flash unit renders the background either too light or too dark. To capture the bluishness, you must eliminate the difference in light levels between the subject (illuminated by the speedlight) and the background (illuminated by natural light)—a difficult task in the manual flash mode. The easiest way to balance the light levels is to use the Nikonos-V and the SB-102 in the TTL automatic mode and follow the procedures explained in **"Daylight Fill-In Flash Photography"** (page 30).

OPTIMUM BATTERY PERFORMANCE

1. New batteries

Between manufacture and first use, all batteries exhibit some drain. Therefore, care should be taken to purchase the newest (and freshest) ones possible. To help you do this, some manufacturers stamp the date of manufacture on the bottom of each battery. Ask your camera dealer for assistance in interpreting the codes.

2. Temperature

Battery life ratings are based on operation at around 25°C (77°F). At other temperatures, battery life is shortened. Spare batteries should therefore be kept available if operation in low temperatures is anticipated.

3. Continuous use

Batteries are drained much more quickly by continuous use than by intermittent use.

4. Storage

When not in use, the batteries should be removed to prevent leakage which may damage the unit, or even cause combustible gases to be trapped inside the battery chamber. To minimize drain during the period of disuse, store the batteries in a cool, dry place below 20°C (68°F).

5. Battery brands

Do not mix brands of batteries or use batteries with different model numbers. Also, avoid mixing new and old batteries since proper performance will not be obtained and battery leakage may occur.

6. Disposal

Do not dispose of batteries by burning. Also, for safety's sake, never disassemble batteries.

7. Polarity

When installing batteries, observe the voltage polarities carefully. Reversal of the positive (+) and negative (-) terminals will result in leakage. If leakage should occur, clean the SB-102 carefully or take it to an authorized Nikon dealer or service center.

The SB-102 requires an excessive current, so the life span of the batteries may be shorter than other speedlights.

8. NiCd batteries

In comparison with regular batteries, NiCd batteries provide faster recycling and higher efficiency at low temperatures. However, the recycling time and the number of flashes per battery set depend upon the age of the batteries, their charges, and their capacities.

- Do not continue to use NiCd batteries after they are exhausted. Continued use may reduce their life span or cause leakage.
- Before charging, thoroughly read the battery and battery charger instructions.
- Charging should only be done for the designated number of hours on a battery charger recommended by the battery manufacturer. Excessive charging may cause battery deterioration.
- Charging should only be done in temperatures between 5°C (41°F) and 35°C (95°F). Never charge batteries while they are still hot from use.
- Never attempt to charge NiCd batteries that are incorrectly installed in the battery charger.
- The charging capacity of NiCd batteries may be shortened after a long period of storage. If this occurs, discharge and recharge them several times.
- If working time is markedly reduced even after they have been correctly charged, replace them with a fresh set.
- Do not mix new and old NiCd batteries.
- Do not use NiCd batteries which have been charged for different lengths of time.



SB-102 or SB-101 (master unit)

When two or more flash units are the same distance from the subject and face approximately the same direction, the combined GN of the units can be determined with the following equation:

$$\text{Combined GN} = \sqrt{\text{GN}_1^2 + \text{GN}_2^2 + \text{GN}_3^2 + \dots}$$

Where GN 1, 2, 3, ... are the guide numbers of the flash units.

• Decrease the slave flash unit's trigger when the light from the master flash unit reaches it directly or is reflected back by the subject. If the light from the master flash unit does not reach the slave flash unit and there are strong light sources nearby, the slave flash unit will not fire. For best results, lock the entire multiple flash system by locking the master flash and before grouping.

• During slave flash photography, avoid different exposure mode combinations on the camera from dual flash units, and trigger your slave unit.

• The slave flash unit may be triggered by 200 ASA film in a black and white bag.

... of the lens...
 ... exposed...
 ... is made...
 ... ground...
 ... distance...
 ... background...
 ... daylight...
 ... When using...
 ... will work...
 ... natural lighting...
 ... daylight...
 ... select...
 ... (number)...
 ... second...
 ... second...
 ... sure...
 ... and...
 ... shutter

Operable shutter speed (1/1000s)



Operable shutter speed (1/1000s)

ACCESSORIES

Numerous accessories are available to increase the SB-102's versatility.

Sensor Unit SU-101

This unit is required when using the SB-102 in the non-TTL automatic flash mode with the Nikonos-V, Nikonos IV-A, or Nikonos III.

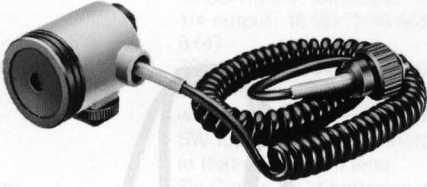

Sensor Holder (for SB-102)

When a plastic frame finder or an optical underwater viewfinder is mounted on the camera's accessory shoe, the sensor holder enables the Sensor Unit SU-101 to be mounted on the bracket.

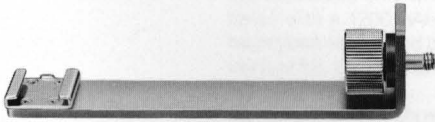

Double Flash Bracket

This accessory allows two flash units to be mounted on the camera at one time, thereby doubling the amount of flash illumination available. This bracket is especially useful during close-up shooting because it enables the subject to be evenly illuminated from the left- and right-hand sides.

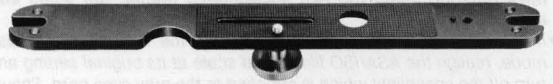

Extension Arm

This accessory increases the length of the arm when a special lighting effect is desired or needed.



ACCESSORIES—continued

Double Sync Cord

When using the Nikonos-V, this cord enables two SB-102 Speedlights to be used in the TTL automatic flash mode.

- **When using two SB-102 Speedlights in the TTL automatic flash mode, the correct shooting situation mark on the exposure calculation dial must be realigned with a + 1 higher speed on the ASA/ISO film speed scale. For example, when using ASA/ISO 100 film, align the correct shooting situation mark with ASA/ISO 200. When you have finished using the two speedlights, realign the scale and mark.**
- **If you decide to use only one speedlight in the TTL automatic flash mode, realign the ASA/ISO film speed scale at its original setting and turn off the speedlight which is attached to the gray sync cord. Should you turn off the speedlight which is attached to the black cord, TTL automatic flash control is automatically canceled and the unit will fire at its maximum output regardless of the setting.**
- **Non-TTL automatic flash exposure is not possible when using two speedlights connected by the optional Double Sync Cord.**

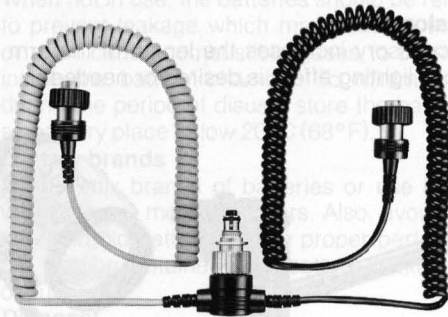

Protectors

Special protectors are available to prevent damage to the SB-102 from inadvertent bumps.

Speedlight Case SS-101 (Provided)

Three cushioned compartments inside this stylish tote bag house the camera and all parts of the Nikonos Speedlight Unit SB-102.



O-rings and lubricant

Additional O-rings and lubricant are available to allow you to maintain the flash unit in perfect condition.

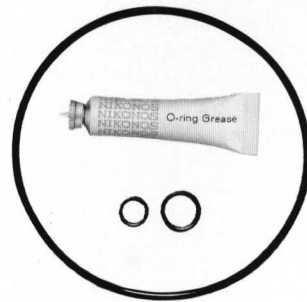

SPECIFICATIONS

Flash Type:	High-performance silicon-controlled rectifier and series circuitry
Useable Exposure Modes:	TTL auto exposure (with Nikonos-V camera); Non-TTL auto exposure (with optional Sensor Unit SU-101); and Manual: "MFULL," "M1/4," and "M1/16" settings
Guide Numbers:	With ASA/ISO 100 film on land (underwater), full output: 32 (16); 1/4 output: 16 (8); 1/16 output: 8 (4)
Angle of Coverage:	79° on land; covers picture angle of 28mm lens on land and underwater; with Wide-Flash Adapter SW-102, picture angle increases to that of a 15mm lens
Batteries:	Six C-type NiCd batteries or six C-type alkaline-manganese batteries (high-performance manganese batteries not recommended)
Number of Flashes/ Recycling Time:	NiCd*: 70 flashes/minimum approx. 5sec.** (depending upon battery brand and amount of recharging) Alkaline-manganese: 120 flashes/minimum approx. 14sec.** * Data for C-type NiCd batteries are applicable only when batteries with a 1200mAh capacity have been recharged by a 120mA current for 15 hours at room temperature. ** More flashes and shorter recycling times in the TTL, non-TTL, "M1/4," and "M1/16" modes
Useable Ranges:	TTL: ASA/ISO film speed coupling range: ASA/ISO 25 to 400; useable aperture range: f/2.8 to f/22 (at ASA/ISO 100); coupling distance range: 0.3m (1ft) to 11m (36.1ft) (at ASA/ISO 100 on land); 0.3m (1ft) to 5.6m (18.4ft) (at ASA/ISO 100 underwater) Non-TTL: Useable apertures: f/4 and f/8 (at ASA/ISO 100); coupling distance range: 0.6m (2ft) to 8m (26.2ft) (at ASA/ISO 100 and f/4 on land); 0.6m (2ft) to 4m (13.1ft) (at ASA/ISO 100 and f/4 underwater); 0.6m (2ft) to 4m (13.1ft) (at ASA/ISO 100 and f/8 on land); 0.6m (2ft) to 2m (6.6ft) (at ASA/ISO 100 and f/8 underwater)
Resistant Pressure:	6kg/cm ² (85 lb/in ²) maximum; useable to depths of 50m (160ft)
Target-Light:	Indicates direction of flash head when T-S switch is at "T.LIGHT" or "T&S"
Slave Flash Function:	Wireless; triggered by light from another flash unit when T-S switch is at "SLAVE" or "T&S"
Dimensions:	Flash head: Approx. 139mm(W) × 152.5mm(H) × 212mm(D)
Weight:	Flash head without batteries: Approx. 1670g

Supplied with ten items: Main flash head (including battery cartridge), joint, bracket (with separate bracket screw), cord fastening hanger, Wide Flash Adapter SW-102, O-ring set, target light, sync cord, arm, and speedlight case SS-101.

Note: All performance data are for normal-temperature operation [25°C (77°F)].

Subject to change without notice.

No reproduction in any form of this manual, in whole or in part (except for brief quotation in critical articles or reviews), may be made without written authorization from the publishers.

Double Sync Cord

When using the Nikon SB-102 Speedlight with the TTL automatic flash mode, the correct shooting situation mark on the ASA/ISO film speed scale. For example, when using the correct shooting situation mark with ASA/ISO 100 film, the camera will automatically set the shutter speed and aperture to the correct values.

When using two SB-102 Speedlights in the TTL automatic flash mode, the correct shooting situation mark on the ASA/ISO film speed scale. For example, when using the correct shooting situation mark with ASA/ISO 100 film, the camera will automatically set the shutter speed and aperture to the correct values.

When using two SB-102 Speedlights in the TTL automatic flash mode, the correct shooting situation mark on the ASA/ISO film speed scale. For example, when using the correct shooting situation mark with ASA/ISO 100 film, the camera will automatically set the shutter speed and aperture to the correct values.

When using two SB-102 Speedlights in the TTL automatic flash mode, the correct shooting situation mark on the ASA/ISO film speed scale. For example, when using the correct shooting situation mark with ASA/ISO 100 film, the camera will automatically set the shutter speed and aperture to the correct values.



NIPPON KOGAKU K.K.

Protectors

Special protectors are available to prevent damage to the SB-102 Speedlight.

Flash Type:	High performance silicon controlled rectifier and series circuitry
Usable Exposure Modes:	<ul style="list-style-type: none"> 1. TTL (Through the Lens) automatic flash mode 2. TTL (Through the Lens) automatic flash mode with optional 28mm (1.1") lens 3. TTL (Through the Lens) automatic flash mode with optional 35mm (1.4") lens 4. TTL (Through the Lens) automatic flash mode with optional 50mm (2.0") lens 5. TTL (Through the Lens) automatic flash mode with optional 75mm (3.0") lens 6. TTL (Through the Lens) automatic flash mode with optional 100mm (4.0") lens 7. TTL (Through the Lens) automatic flash mode with optional 135mm (5.3") lens 8. TTL (Through the Lens) automatic flash mode with optional 180mm (7.1") lens 9. TTL (Through the Lens) automatic flash mode with optional 200mm (8.0") lens 10. TTL (Through the Lens) automatic flash mode with optional 250mm (10.0") lens 11. TTL (Through the Lens) automatic flash mode with optional 300mm (12.0") lens 12. TTL (Through the Lens) automatic flash mode with optional 400mm (16.0") lens 13. TTL (Through the Lens) automatic flash mode with optional 500mm (20.0") lens 14. TTL (Through the Lens) automatic flash mode with optional 600mm (24.0") lens 15. TTL (Through the Lens) automatic flash mode with optional 800mm (32.0") lens 16. TTL (Through the Lens) automatic flash mode with optional 1000mm (40.0") lens
Guide Numbers:	<ul style="list-style-type: none"> 1. ASA/ISO 100 film on land (underwater): 110m (36') 2. ASA/ISO 100 film on land (underwater): 110m (36') 3. ASA/ISO 100 film on land (underwater): 110m (36') 4. ASA/ISO 100 film on land (underwater): 110m (36') 5. ASA/ISO 100 film on land (underwater): 110m (36') 6. ASA/ISO 100 film on land (underwater): 110m (36') 7. ASA/ISO 100 film on land (underwater): 110m (36') 8. ASA/ISO 100 film on land (underwater): 110m (36') 9. ASA/ISO 100 film on land (underwater): 110m (36') 10. ASA/ISO 100 film on land (underwater): 110m (36') 11. ASA/ISO 100 film on land (underwater): 110m (36') 12. ASA/ISO 100 film on land (underwater): 110m (36') 13. ASA/ISO 100 film on land (underwater): 110m (36') 14. ASA/ISO 100 film on land (underwater): 110m (36') 15. ASA/ISO 100 film on land (underwater): 110m (36') 16. ASA/ISO 100 film on land (underwater): 110m (36') 17. ASA/ISO 100 film on land (underwater): 110m (36') 18. ASA/ISO 100 film on land (underwater): 110m (36') 19. ASA/ISO 100 film on land (underwater): 110m (36') 20. ASA/ISO 100 film on land (underwater): 110m (36')
Angle of Coverage:	28mm (1.1") lens: 60° 35mm (1.4") lens: 54° 50mm (2.0") lens: 45° 75mm (3.0") lens: 36° 100mm (4.0") lens: 27° 135mm (5.3") lens: 18° 180mm (7.1") lens: 14° 200mm (8.0") lens: 13° 250mm (10.0") lens: 11° 300mm (12.0") lens: 9° 400mm (16.0") lens: 7° 500mm (20.0") lens: 6° 600mm (24.0") lens: 5° 800mm (32.0") lens: 4° 1000mm (40.0") lens: 3°
Batteries:	<ul style="list-style-type: none"> 1. Six C-type NiCd batteries or six C-type alkaline batteries 2. Six C-type NiCd batteries or six C-type alkaline batteries 3. Six C-type NiCd batteries or six C-type alkaline batteries 4. Six C-type NiCd batteries or six C-type alkaline batteries 5. Six C-type NiCd batteries or six C-type alkaline batteries 6. Six C-type NiCd batteries or six C-type alkaline batteries 7. Six C-type NiCd batteries or six C-type alkaline batteries 8. Six C-type NiCd batteries or six C-type alkaline batteries 9. Six C-type NiCd batteries or six C-type alkaline batteries 10. Six C-type NiCd batteries or six C-type alkaline batteries 11. Six C-type NiCd batteries or six C-type alkaline batteries 12. Six C-type NiCd batteries or six C-type alkaline batteries 13. Six C-type NiCd batteries or six C-type alkaline batteries 14. Six C-type NiCd batteries or six C-type alkaline batteries 15. Six C-type NiCd batteries or six C-type alkaline batteries 16. Six C-type NiCd batteries or six C-type alkaline batteries 17. Six C-type NiCd batteries or six C-type alkaline batteries 18. Six C-type NiCd batteries or six C-type alkaline batteries 19. Six C-type NiCd batteries or six C-type alkaline batteries 20. Six C-type NiCd batteries or six C-type alkaline batteries
Number of Flashes/Recycling Time:	<ul style="list-style-type: none"> 1. 120 flashes (15 minutes) 2. 120 flashes (15 minutes) 3. 120 flashes (15 minutes) 4. 120 flashes (15 minutes) 5. 120 flashes (15 minutes) 6. 120 flashes (15 minutes) 7. 120 flashes (15 minutes) 8. 120 flashes (15 minutes) 9. 120 flashes (15 minutes) 10. 120 flashes (15 minutes) 11. 120 flashes (15 minutes) 12. 120 flashes (15 minutes) 13. 120 flashes (15 minutes) 14. 120 flashes (15 minutes) 15. 120 flashes (15 minutes) 16. 120 flashes (15 minutes) 17. 120 flashes (15 minutes) 18. 120 flashes (15 minutes) 19. 120 flashes (15 minutes) 20. 120 flashes (15 minutes)
Weight:	Approx. 1870g
Dimensions:	152mm (H) x 121mm (D)
Slave Flash Function:	When T-Switch is set to "SLAVE" or "T.S.", another flash unit when T-Switch is set to "SLAVE" or "T.S."
Target Light:	Indicates direction of flash head when T-Switch is set to "LIGHT" or "T.S."
Resistant Pressure:	Up to 10m (33ft) underwater